

*Princess® and Victoria®
Frameless Tub and Shower Enclosures*

PRICE LIST

For
Beauty
Comfort
and
Convenience



Princess[®] Series Price List NO. 3

February 2009

1/4" DIAMOND POLISHED BEVEL TEMPERED GLASS

We request that all orders for the **Princess Series** enclosures be placed in writing. All orders must be placed via fax or by mail. Orders will not be placed until the appropriate Style-rite measuring form is received with all of the appropriate dimensions.

Style-rite is not responsible for any inaccuracy in the measurements supplied to us.

Style-rite is not responsible for any personal injury or property damage that may occur when the unit is measured or installed at the customer location.

Orders built to customer specifications will require a 50% production deposit. The remaining balance is per our standard terms.

Orders cancelled during the production period will be pro-rated to the amount of work that has been done on the enclosure including material, labor and custom ordered glass charges.

Style-rite extends to the original consumer purchaser a 3 year limited warranty from the date of purchase on all Style-rite fabricated tub and shower enclosures against defects in material and workmanship. Any enclosure, which proves to be defective under normal use during the warranty period, will be at Style-rites option to repair or replace with a new or improved part. Style-rite is not responsible for labor, installation costs or shipping charges for the repair or replacement of the defective merchandise. This warranty does not cover defects caused by: improper installation, alteration, misuse or misapplication, maintenance, careless handling, use of harsh chemicals, abrasives, discoloration, or stains due to improper water chemistry. Brass finishes including but not limited to towel bars and pulls are not warranted against discoloration or tarnishing due to the inherent characteristics of brass. A coating of Emron or lacquer is applied to brass hardware that helps to protect against discoloration or tarnishing. Except as provided herein, Style-rite makes no warranties either expressed or implied, as to any matter whatsoever including the condition of the merchandise or fitness for a particular purpose. Any warranty implied by law and not effectively excluded by this warranty, is limited to the duration and remedies of this warranty. In no event shall Style-rite be liable for consequential or incidental damages. Glass is not warranted against breakage.

Style-Rite of America[®], founded in 1953, is a premier manufacturer of framed and frameless tub and shower enclosures. Style-rite utilizes the finest materials and hand craftsmanship in the industry, giving the customer a superior product. The **Princess Series** of sliding tub and shower enclosures incorporate the new SR Building Block system[™] and guidance system. The SR Building Block System[™] consists of interlocking extrusions, which allow flexibility and design options.

PRINCESS® SLIDING TUB AND SHOWER ENCLOSURES

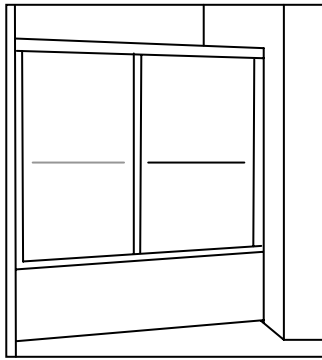

90-L, 90
Pages 3,4

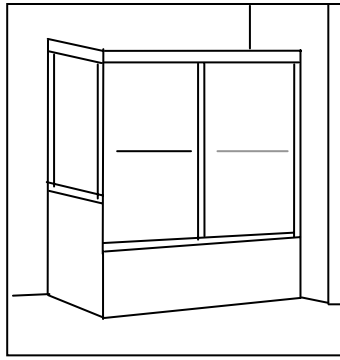

932-B
Page 9

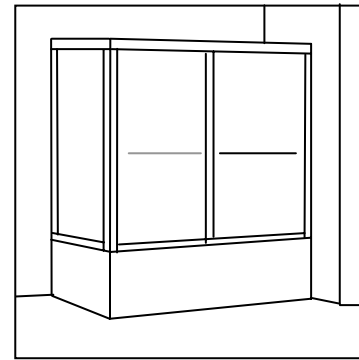

932
Page 10

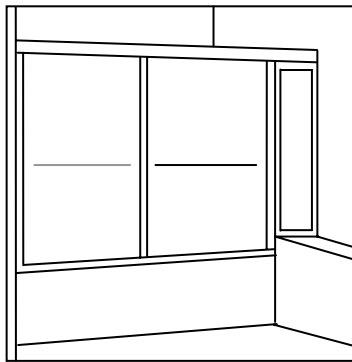

944
Page 7

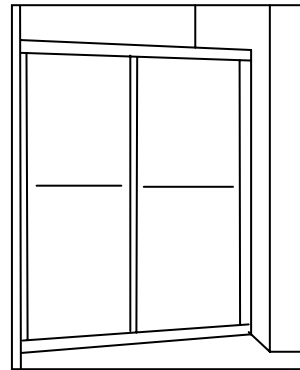

981, 981-H
Pages 5,6

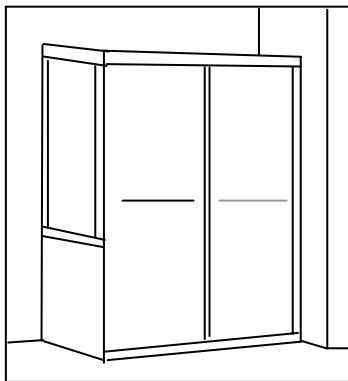

982-B
Page 11

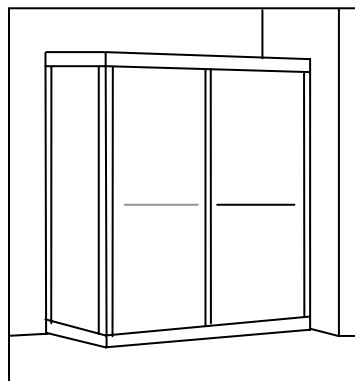

982
Page 12

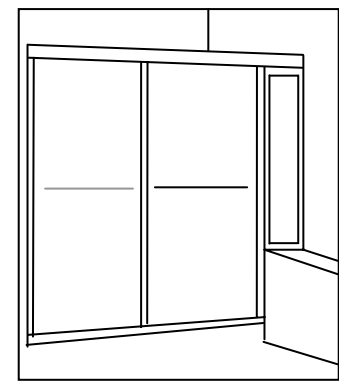

944-H
Page 8

INTRODUCTION TO VICTORIA	PAGE 13
VICTORIA INDEX	14
ALUMINUM FINISHES	25
GLASS CHARACTERISTICS	25
OPTIONS	25
POLICIES	26
SPECIFICATIONS	BACK PAGE

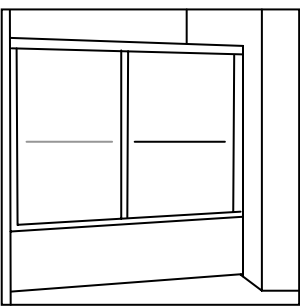

PRINCESS® FRAMELESS TUB ENCLOSURE
1/4" DIAMOND POLISHED BEVEL GLASS
STANDARD HEIGHT 56 1/2"

TWO ROLLING PANELS WITH ADJUSTABLE BALL BEARING OVERHEAD SUSPENSION. CLEAN-RITE® OPEN BOTTOM TRACK. HEADER BAR IS REVERSIBLE FOR A ROUND OR A SEMI-FLAT APPEARANCE. HIGH QUALITY THRU THE GLASS TUBULAR BRASS OR 300 SERIES STAINLESS STEEL TOWEL BARS AND KNOBS, CHROME PLATED, 24K GOLD PLATED OR POWDER COATED TO MATCH THE ENCLOSURES FINISH.

MODEL NUMBER	TO FIT OPENING MIN. TO MAX.	PASS THRU OPENING	CLEAR	BRONZE OR GRAY	PEBBLE	3/16" RAIN	FLUTED
PLEASE ORDER BY MODEL NO. 90-L465	42 1/2"	17"	\$645	\$722	\$754	\$859	\$1,273
	43 1/2"	18"	↓	↓	↓	↓	↓
	44 1/2"	19"	↓	↓	↓	↓	↓
	45 1/2"	20"	↓	↓	↓	↓	↓
	46 1/2"	21"	↓	↓	↓	↓	↓
	47 1/2"	22"	↓	↓	↓	↓	↓
90-L525	48"	19 1/2"	\$687	\$774	\$810	\$928	\$1,394
	48 1/2"	20"	↓	↓	↓	↓	↓
	49 1/2"	21"	↓	↓	↓	↓	↓
	50 1/2"	22"	↓	↓	↓	↓	↓
	51 1/2"	23"	↓	↓	↓	↓	↓
	52 1/2"	24"	↓	↓	↓	↓	↓
90-L565 90-L585	54"	22 1/2"	\$657	\$828	\$869	\$999	\$1,516
	54 1/2"	23"	↓	↓	↓	↓	↓
	55 1/2"	24"	↓	↓	↓	↓	↓
	56 1/2"	25"	↓	↓	↓	↓	↓
	57 1/2"	26"	↓	↓	↓	↓	↓
	58 1/2"	27"	\$725	↓	↓	↓	↓
90-L645	59 1/2"	28"	↓	↓	↓	↓	↓
	60"	25 1/2"	\$775	\$881	\$926	\$1,070	\$1,639
	60 1/2"	26"	↓	↓	↓	↓	↓
	61 1/2"	27"	↓	↓	↓	↓	↓
	62 1/2"	28"	↓	↓	↓	↓	↓
	63 1/2"	29"	↓	↓	↓	↓	↓
90-L705	64 1/2"	30"	↓	↓	↓	↓	↓
	65 1/2"	31"	↓	↓	↓	↓	↓
	66"	28 1/2"	\$818	\$934	\$982	\$1,139	\$1,760
	66 1/2"	29"	↓	↓	↓	↓	↓
	67 1/2"	30"	↓	↓	↓	↓	↓
	68 1/2"	31"	↓	↓	↓	↓	↓
90-L705	69 1/2"	32"	↓	↓	↓	↓	↓
	70 1/2"	33"	↓	↓	↓	↓	↓
	71 1/2"	34"	↓	↓	↓	↓	↓
			↓	↓	↓	↓	↓

CUSTOM HEIGHT: SEE MODEL NO. 981-H.

CUTTING LESS THEN STANDARD HEIGHT: ADD 70% TO UNIT LIST PRICE. ADD -CH TO MODEL NO.

BRUSHED SATIN NICKEL FINISH: ADD TO LIST \$ 100.

GOLD ANODIZED FINISH: ADD TO LIST \$ 60.

POWDER COATED FINISH: ALMOND, BISCUIT, BLACK, BONE, CAMEO CREAM, OIL RUBBED BRONZE OR WHITE: ADD TO LIST \$ 300.

CUSTOM COLORS: CONSULT FACTORY.

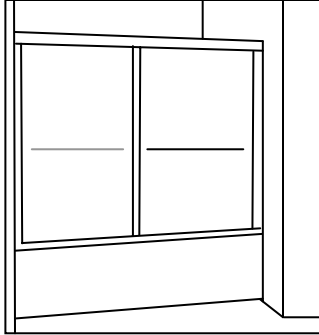

PRINCESS® FRAMELESS TUB ENCLOSURE
1/4" DIAMOND POLISHED BEVEL GLASS
STANDARD HEIGHT 58 1/2"

TWO ROLLING PANELS WITH ADJUSTABLE BALL BEARING OVERHEAD SUSPENSION. CLEAN-RITE® OPEN BOTTOM TRACK. HEADER BAR IS REVERSIBLE FOR A ROUND OR A SEMI-FLAT APPEARANCE. HIGH QUALITY THRU THE GLASS TUBULAR BRASS OR 300 SERIES STAINLESS STEEL TOWEL BARS AND KNOBS, CHROME PLATED, 24K GOLD PLATED OR POWDER COATED TO MATCH THE ENCLOSURES FINISH.

MODEL NUMBER	TO FIT OPENING MIN. TO MAX.	PASS THRU OPENING	CLEAR	BRONZE OR GRAY	PEBBLE	3/16" RAIN	FLUTED
PLEASE ORDER BY MODEL NO. 90-465	42 1/2"	17"	\$486	\$735	\$769	\$877	\$1,306
	43 1/2"	18"	↓	↓	↓	↓	↓
	44 1/2"	19"	↓	↓	↓	↓	↓
	45 1/2"	20"	↓	↓	↓	↓	↓
	46 1/2"	21"	↓	↓	↓	↓	↓
	47 1/2"	22"	↓	↓	↓	↓	↓
90-525	48"	19 1/2"	\$536	\$788	\$826	\$948	\$1,431
	48 1/2"	20"	↓	↓	↓	↓	↓
	49 1/2"	21"	↓	↓	↓	↓	↓
	50 1/2"	22"	↓	↓	↓	↓	↓
	51 1/2"	23"	↓	↓	↓	↓	↓
	52 1/2"	24"	↓	↓	↓	↓	↓
90-585	54"	22 1/2"	\$591	\$844	\$886	\$1,021	\$1,558
	54 1/2"	23"	↓	↓	↓	↓	↓
	55 1/2"	24"	↓	↓	↓	↓	↓
	56 1/2"	25"	↓	↓	↓	↓	↓
	57 1/2"	26"	↓	↓	↓	↓	↓
	58 1/2"	27"	↓	↓	↓	↓	↓
90-645	59 1/2"	28"	↓	↓	↓	↓	↓
	60"	25 1/2"	\$626	\$898	\$944	\$1,094	\$1,684
	60 1/2"	26"	↓	↓	↓	↓	↓
	61 1/2"	27"	↓	↓	↓	↓	↓
	62 1/2"	28"	↓	↓	↓	↓	↓
	63 1/2"	29"	↓	↓	↓	↓	↓
90-705	64 1/2"	30"	↓	↓	↓	↓	↓
	65 1/2"	31"	↓	↓	↓	↓	↓
	66"	28 1/2"	\$832	\$952	\$1,002	\$1,165	\$1,809
	66 1/2"	29"	↓	↓	↓	↓	↓
	67 1/2"	30"	↓	↓	↓	↓	↓
	68 1/2"	31"	↓	↓	↓	↓	↓
90-705	69 1/2"	32"	↓	↓	↓	↓	↓
	70 1/2"	33"	↓	↓	↓	↓	↓
	71 1/2"	34"	↓	↓	↓	↓	↓
			↓	↓	↓	↓	↓

CUSTOM HEIGHT: SEE MODEL NO. 981-H.

CUTTING LESS THEN STANDARD HEIGHT: ADD 70% TO UNIT LIST PRICE. ADD -CH TO MODEL NO.

BRUSHED SATIN NICKEL FINISH: ADD TO LIST \$ 100.

GOLD ANODIZED FINISH: ADD TO LIST \$ 60.

POWDER COATED FINISH: ALMOND, BISCUIT, BLACK, BONE, CAMEO CREAM, OIL RUBBED BRONZE OR WHITE: ADD TO LIST \$ 300.

CUSTOM COLORS: CONSULT FACTORY.

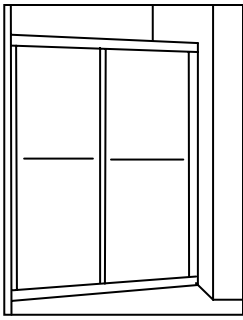

PRINCESS® FRAMELESS SHOWER ENCLOSURE
1/4" DIAMOND POLISHED BEVEL GLASS
STANDARD HEIGHT 66 1/2"

TWO ROLLING PANELS WITH ADJUSTABLE BALL BEARING OVERHEAD SUSPENSION. CLEAN-RITE® OPEN BOTTOM TRACK. HEADER BAR IS REVERSIBLE FOR A ROUND OR A SEMI-FLAT APPEARANCE. HIGH QUALITY THRU THE GLASS TUBULAR BRASS OR 300 SERIES STAINLESS STEEL TOWEL BARS AND KNOBS, CHROME PLATED, 24K GOLD PLATED OR POWDER COATED TO MATCH THE ENCLOSURES FINISH.

MODEL NUMBER	TO FIT OPENING MIN. TO MAX	PASS THRU OPENING	CLEAR	BRONZE OR GRAY	PEBBLE	3/16" RAIN	FLUTED
PLEASE ORDER BY MODEL NO. 981-445	40 1/2"	16 1/2"	\$547	\$793	\$831	\$955	\$1,446
	41 1/2"	17 1/2"					
	42 1/2"	18 1/2"					
	43 1/2"	19 1/2"					
	44 1/2"	20 1/2"					
981-465	45 1/2"	20"	↓	↓	↓	↓	↓
	46 1/2"	21"					
	47 1/2"	22"					
981-525	48"	19 1/2"	\$579	\$851	\$894	\$1,034	\$1,586
	48 1/2"	20"					
	49 1/2"	21"					
	50 1/2"	22"					
	51 1/2"	23"					
	52 1/2"	24"					
	53 1/2"	25"					
981-585	54"	22 1/2"	\$604	\$911	\$959	\$1,114	\$1,727
	54 1/2"	23"					
	55 1/2"	24"					
	56 1/2"	25"					
	57 1/2"	26"					
	58 1/2"	27"					
	59 1/2"	28"					
981-645	60"	25 1/2"	\$845	\$971	\$1,024	\$1,194	\$1,868
	60 1/2"	26"					
	61 1/2"	27"					
	62 1/2"	28"					
	63 1/2"	29"					
	64 1/2"	30"					
	65 1/2"	31"					
981-705	66"	28 1/2"	\$893	\$1,029	\$1,087	\$1,273	\$2,009
	66 1/2"	29"					
	67 1/2"	30"					
	68 1/2"	31"					
	69 1/2"	32"					
	70 1/2"	33"					
	71 1/2"	34"					

CUSTOM HEIGHT: SEE MODEL NO. 981-H. CUTTING LESS THAN STANDARD HEIGHT: ADD 70% TO UNIT LIST PRICE.
 ADD -CH TO MODEL NO.
 BRUSHED SATIN NICKEL FINISH: ADD TO LIST \$100.
 GOLD ANODIZED FINISH: ADD TO LIST \$60.
 POWDER COATED FINISH: ALMOND, BISCUIT, BLACK, BONE, CAMEO CREAM, OIL RUBBED BRONZE OR WHITE: ADD TO \$300. CUSTOM COLORS: CONSULT THE FACTOR.

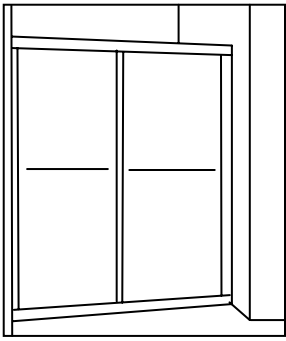

PRINCESS® FRAMELESS SHOWER ENCLOSURE
1/4" DIAMOND POLISHED BEVEL GLASS
STANDARD HEIGHT 71 1/2"

TWO ROLLING PANELS WITH ADJUSTABLE BALL BEARING OVERHEAD SUSPENSION. CLEAN-RITE® OPEN BOTTOM TRACK. HEADER BAR IS REVERSIBLE FOR A ROUND OR A SEMI-FLAT APPEARANCE. HIGH QUALITY THRU THE GLASS TUBULAR BRASS OR 300 SERIES STAINLESS STEEL TOWEL BARS AND KNOBS, CHROME PLATED, 24K GOLD PLATED OR POWDER COATED TO MATCH THE ENCLOSURES FINISH.

MODEL NUMBER	TO FIT OPENING MIN. TO MAX.	PASS THRU OPENING	CLEAR	BRONZE OR GRAY	PEBBLE	3/16" RAIN	FLUTED
PLEASE ORDER BY MODEL NO. 981-H465	42 1/2"	17"	\$545	\$816	\$857	\$989	\$1,510
	43 1/2"	18"	↓	↓	↓	↓	↓
	44 1/2"	19"	↓	↓	↓	↓	↓
	45 1/2"	20"	↓	↓	↓	↓	↓
	46 1/2"	21"	↓	↓	↓	↓	↓
	47 1/2"	22"	↓	↓	↓	↓	↓
981-H525	48"	19 1/2"	\$594	\$877	\$923	\$1,071	\$1,657
	48 1/2"	20"	↓	↓	↓	↓	↓
	49 1/2"	21"	↓	↓	↓	↓	↓
	50 1/2"	22"	↓	↓	↓	↓	↓
	51 1/2"	23"	↓	↓	↓	↓	↓
	52 1/2"	24"	↓	↓	↓	↓	↓
981-H585	53 1/2"	25"	↓	↓	↓	↓	↓
	54"	22 1/2"	\$627	\$939	\$991	\$1,155	\$1,807
	54 1/2"	23"	↓	↓	↓	↓	↓
	55 1/2"	24"	↓	↓	↓	↓	↓
	56 1/2"	25"	↓	↓	↓	↓	↓
	57 1/2"	26"	↓	↓	↓	↓	↓
981-H645	58 1/2"	27"	↓	↓	↓	↓	↓
	59 1/2"	28"	↓	↓	↓	↓	↓
	60"	25 1/2"	\$685	\$1,001	\$1,058	\$1,239	\$1,955
	60 1/2"	26"	↓	↓	↓	↓	↓
	61 1/2"	27"	↓	↓	↓	↓	↓
	62 1/2"	28"	↓	↓	↓	↓	↓
981-H705	63 1/2"	29"	↓	↓	↓	↓	↓
	64 1/2"	30"	↓	↓	↓	↓	↓
	65 1/2"	31"	↓	↓	↓	↓	↓
	66"	28 1/2"	\$917	\$1,062	\$1,124	\$1,322	\$2,103
	66 1/2"	29"	↓	↓	↓	↓	↓
	67 1/2"	30"	↓	↓	↓	↓	↓
981-H705	68 1/2"	31"	↓	↓	↓	↓	↓
	69 1/2"	32"	↓	↓	↓	↓	↓
	70 1/2"	33"	↓	↓	↓	↓	↓
	71 1/2"	34"	↓	↓	↓	↓	↓

CUTTING LESS THEN STANDARD HEIGHT: ADD 70% TO UNIT LIST PRICE. ADD -CH TO MODEL NO.

BRUSHED SATIN NICKEL FINISH: ADD TO LIST \$ 100.

GOLD ANODIZED FINISH: ADD TO LIST \$ 60.

POWDER COATED FINISH: ALMOND, BISCUIT, BLACK, BONE, CAMEO CREAM, OIL RUBBED BRONZE OR WHITE: ADD TO LIST \$ 300.

CUSTOM COLORS: CONSULT FACTORY.

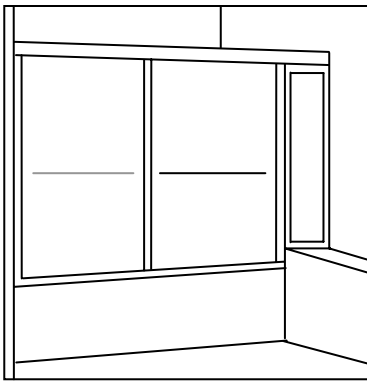

**PRINCESS® FRAMELESS TUB ENCLOSURE
WITH IN-LINE PANEL
1/4" DIAMOND POLISHED BEVEL GLASS
STANDARD HEIGHT 58 1/2"**

TWO ROLLING PANELS WITH ADJUSTABLE BALL BEARING OVERHEAD SUSPENSION AND ADJACENT STATIONARY PANEL. CLEAN-RITE® OPEN BOTTOM TRACK. HEADER BAR IS REVERSIBLE FOR A ROUND OR A SEMI-FLAT APPEARANCE. HIGH QUALITY THRU THE GLASS TUBULAR BRASS OR 300 SERIES STAINLESS STEEL TOWEL BARS AND KNOBS ON BOTH ROLLING PANELS, CHROME PLATED, 24K GOLD PLATED OR POWDER COATED TO MATCH THE ENCLOSURES FINISH.

MODEL NUMBER	OPENING WIDTH	PASS THRU OPENING	CLEAR	BRONZE OR GRAY	PEBBLE	3/16"RAIN	FLUTED
944-01	TUB CTRL 42 1/2" TO 47 1/2" IN-LINE PANEL TO 12"	17" TO 22"	\$771	\$898	\$952	\$1,125	\$1,740
944-02	TUB CTRL 42 1/2" TO 47 1/2" IN-LINE PANEL TO 24"	17" TO 22"	\$850	\$1,001	\$1,064	\$1,269	\$2,009
944-03	TUB CTRL 42 1/2" TO 47 1/2" IN-LINE PANEL TO 36"	17" TO 22"	\$934	\$1,110	\$1,184	\$1,423	\$2,298
944-04	TUB CTRL 48" TO 53 1/2" IN-LINE PANEL TO 12"	19 1/2" TO 25"	\$775	\$915	\$974	\$1,164	\$1,844
944-05	TUB CTRL 48" TO 53 1/2" IN-LINE PANEL TO 24"	19 1/2" TO 25"	\$893	\$1,056	\$1,125	\$1,347	\$2,152
944-06	TUB CTRL 48" TO 53 1/2" IN-LINE PANEL TO 36"	19 1/2" TO 25"	\$977	\$1,165	\$1,245	\$1,501	\$2,441
944-07	TUB CTRL 54" TO 59 1/2" IN-LINE PANEL TO 12"	22 1/2" TO 28"	\$831	\$983	\$1,048	\$1,255	\$1,999
944-08	TUB CTRL 54" TO 59 1/2" IN-LINE PANEL TO 24"	22 1/2" TO 28"	\$937	\$1,112	\$1,186	\$1,425	\$2,295
944-09	TUB CTRL 54" TO 59 1/2" IN-LINE PANEL TO 36"	22 1/2" TO 28"	\$1,021	\$1,221	\$1,306	\$1,579	\$2,584
944-10	TUB CTRL 60" TO 65 1/2" IN-LINE PANEL TO 12"	25 1/2" TO 31"	\$885	\$1,050	\$1,120	\$1,344	\$2,153
944-11	TUB CTRL 60" TO 65 1/2" IN-LINE PANEL TO 24"	25 1/2" TO 31"	\$980	\$1,168	\$1,247	\$1,503	\$2,438
944-12	TUB CTRL 60" TO 65 1/2" IN-LINE PANEL TO 36"	25 1/2" TO 31"	\$1,064	\$1,277	\$1,367	\$1,657	\$2,726
944-13	TUB CTRL 66" TO 71 1/2" IN-LINE PANEL TO 12"	28 1/2" TO 34"	\$939	\$1,116	\$1,191	\$1,433	\$2,307
944-14	TUB CTRL 66" TO 71 1/2" IN-LINE PANEL TO 24"	28 1/2" TO 34"	\$1,023	\$1,223	\$1,308	\$1,581	\$2,581
944-15	TUB CTRL 66" TO 71 1/2" IN-LINE PANEL TO 36"	28 1/2" TO 34"	\$1,107	\$1,333	\$1,428	\$1,735	\$2,869

NOTE: IN-LINE PANEL SMALLER THEN 5" IS SUPPLIED WITH ALUMINUM FILLERS- ADD TO LIST \$ 98.

NOTE: WHEN ORDERING, PLEASE PROVIDE CENTERLINE MEASUREMENTS OF BASE, SEAT, LOCATION OF SEAT LEFT OR RIGHT, AND HEIGHT FROM TOP OF BASE TO TOP OF SEAT.

CUTTING LESS THEN STANDARD HEIGHT: ADD 70% TO UNIT LIST PRICE. AND -CH TO MODEL NO.

BRUSHED SATIN NICKEL FINISH: ADD TO LIST \$ 150.

GOLD ANODIZED FINISH: ADD TO LIST \$ 90.

POWDER COATED FINISH: ALMOND, BISCUIT, BLACK, BONE, CAMEO CREAM, OIL RUBBED BRONZE OR WHITE: ADD TO LIST \$ 450.

CUSTOM COLORS: CONSULT FACTORY.

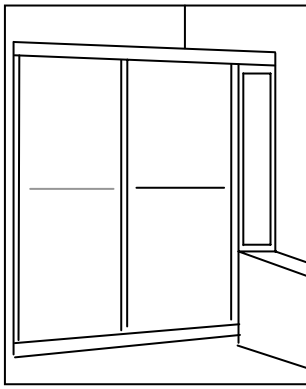

**PRINCESS® FRAMELESS SHOWER ENCLOSURE
WITH IN-LINE PANEL
1/4" DIAMOND POLISHED BEVEL GLASS
STANDARD HEIGHT 71 1/2"**

TWO ROLLING PANELS WITH ADJUSTABLE BALL BEARING OVERHEAD SUSPENSION AND ADJACENT STATIONARY PANEL. CLEAN-RITE® OPEN BOTTOM TRACK. HEADER BAR IS REVERSIBLE FOR A ROUND OR A SEMI-FLAT APPEARANCE. HIGH QUALITY THRU THE GLASS TUBULAR BRASS OR 300 SERIES STAINLESS STEEL TOWEL BARS AND KNOBS ON BOTH ROLLING PANELS, CHROME PLATED, 24K GOLD PLATED OR POWDER COATED TO MATCH THE ENCLOSURES FINISH.

MODEL NUMBER	OPENING WIDTH	PASS THRU OPENING	CLEAR	BRONZE OR GRAY	PEBBLE	3/16" RAIN	FLUTED
944-H-01	BASE CTRL 42 1/2" TO 47 1/2" IN-LINE PANEL TO 12"	17" TO 22"	\$858	\$1,010	\$1,074	\$1,281	\$2,100
944-H-02	BASE CTRL 42 1/2" TO 47 1/2" IN-LINE PANEL TO 24"	17" TO 22"	\$955	\$1,138	\$1,215	\$1,463	\$2,446
944-H-03	BASE CTRL 42 1/2" TO 47 1/2" IN-LINE PANEL TO 36"	17" TO 22"	\$1,052	\$1,265	\$1,356	\$1,646	\$2,792
944-H-04	BASE CTRL 48" TO 53 1/2" IN-LINE PANEL TO 12"	19 1/2" TO 25"	\$860	\$1,027	\$1,098	\$1,326	\$2,227
944-H-05	BASE CTRL 48" TO 53 1/2" IN-LINE PANEL TO 24"	19 1/2" TO 25"	\$1,005	\$1,203	\$1,286	\$1,556	\$2,620
944-H-06	BASE CTRL 48" TO 53 1/2" IN-LINE PANEL TO 36"	19 1/2" TO 25"	\$1,102	\$1,330	\$1,427	\$1,738	\$2,966
944-H-07	BASE CTRL 54" TO 59 1/2" IN-LINE PANEL TO 12"	22 1/2" TO 28"	\$922	\$1,105	\$1,182	\$1,430	\$2,413
944-H-08	BASE CTRL 54" TO 59 1/2" IN-LINE PANEL TO 24"	22 1/2" TO 28"	\$1,055	\$1,268	\$1,358	\$1,648	\$2,794
944-H-09	BASE CTRL 54" TO 59 1/2" IN-LINE PANEL TO 36"	22 1/2" TO 28"	\$1,152	\$1,395	\$1,499	\$1,830	\$3,140
944-H-10	BASE CTRL 60" TO 65 1/2" IN-LINE PANEL TO 12"	25 1/2" TO 31"	\$983	\$1,181	\$1,265	\$1,534	\$2,598
944-H-11	BASE CTRL 60" TO 65 1/2" IN-LINE PANEL TO 24"	25 1/2" TO 31"	\$1,104	\$1,333	\$1,429	\$1,740	\$2,968
944-H-12	BASE CTRL 60" TO 65 1/2" IN-LINE PANEL TO 36"	25 1/2" TO 31"	\$1,202	\$1,460	\$1,570	\$1,922	\$3,314
944-H-13	BASE CTRL 66" TO 71 1/2" IN-LINE PANEL TO 12"	28 1/2" TO 34"	\$1,043	\$1,256	\$1,347	\$1,637	\$2,783
944-H-14	BASE CTRL 66" TO 71 1/2" IN-LINE PANEL TO 24"	28 1/2" TO 34"	\$1,154	\$1,398	\$1,501	\$1,832	\$3,142
944-H-15	BASE CTRL 66" TO 71 1/2" IN-LINE PANEL TO 36"	28 1/2" TO 34"	\$1,251	\$1,525	\$1,641	\$2,014	\$3,488

NOTE: IN-LINE PANEL SMALLER THEN 5" IS SUPPLIED WITH ALUMINUM FILLERS – ADD TIO LIST \$ 98.

NOTE: WHEN ORDERING, PLEASE PROVIDE CENTERLINE MEASUREMENTS OF BASE, SEAT, LOCATION OF SEAT LEFT OR RIGHT, AND HEIGHT FROM TOP OF BASE TO TOP OF SEAT.

CUTTING LESS THEN STANDARD HEIGHT: ADD 70% TO UNIT LIST PRICE. ADD –CH TO MODEL NUMBER.

BRUSHED SATIN NICKEL FINISH: ADD TO LIST \$ 150.

GOLD ANODIZED FINISH: ADD TO LIST \$ 90.

POWDER COATED FINISH: ALMOND, BISCUIT, BLACK, BONE, CAMEO CREAM, OIL RUBBED BRONZE OR WHITE: ADD TO LIST \$ 450.

CUSTOM COLORS: CONSULT FACTORY.

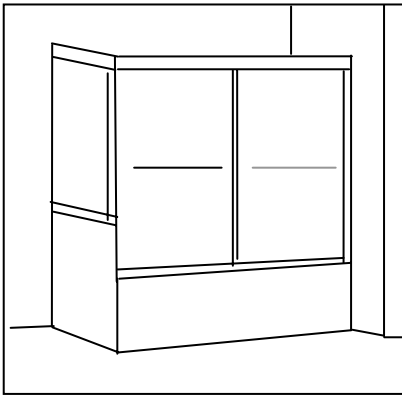

**PRINCESS® FRAMELESS TUB ENCLOSURE
WITH 90° BUTTRESS RETURN PANEL
1/4" DIAMOND POLISHED BEVEL GLASS
STANDARD HEIGHT 58 1/2"**

TWO ROLLING PANELS WITH ADJUSTABLE BALL BEARING OVERHEAD SUSPENSION. CLEAN-RITE® OPEN BOTTOM TRACK. HEADER BAR IS REVERSIBLE FOR A ROUND OR A SEMI-FLAT APPEARANCE. HIGH QUALITY THRU THE GLASS TUBULAR BRASS OR 300 SERIES STAINLESS STEEL TOWEL BARS AND KNOBS ON BOTH ROLLING PANELS, CHROME PLATED, 24K GOLD PLATED OR POWDER COATED TO MATCH THE ENCLOSURES FINISH.

MODEL NUMBER	OPENING WIDTH	PASS THRU OPENING	CLEAR	BRONZE OR GRAY	PEBBLE	3/16"RAIN	FLUTED
932-B-01	FRONT CTRL 42 1/2" TO 47 1/2" RETURN PANEL TO 30"	17" TO 22"	\$968	\$1,131	\$1,200	\$1,422	\$2,298
932-B-02	FRONT CTRL 42 1/2" TO 47 1/2" RETURN PANEL TO 36"	17" TO 22"	\$1,013	\$1,189	\$1,263	\$1,502	\$2,445
932-B-03	FRONT CTRL 42 1/2" TO 47 1/2" RETURN PANEL TO 42"	17" TO 22"	\$1,058	\$1,246	\$1,326	\$1,581	\$2,593
932-B-04	FRONT CTRL 48" TO 53 1/2" RETURN PANEL TO 30"	19 1/2" TO 25"	\$1,021	\$1,197	\$1,271	\$1,510	\$2,454
932-B-05	FRONT CTRL 48" TO 53 1/2" RETURN PANEL TO 36"	19 1/2" TO 25"	\$1,056	\$1,244	\$1,324	\$1,580	\$2,591
932-B-06	FRONT CTRL 48" TO 53 1/2" RETURN PANEL TO 42"	19 1/2" TO 25"	\$1,101	\$1,302	\$1,387	\$1,659	\$2,738
932-B-07	FRONT CTRL 54" TO 59 1/2" RETURN PANEL TO 30"	22 1/2" TO 28"	\$1,077	\$1,265	\$1,344	\$1,600	\$2,611
932-B-08	FRONT CTRL 54" TO 59 1/2" RETURN PANEL TO 36"	22 1/2" TO 28"	\$1,099	\$1,300	\$1,385	\$1,658	\$2,736
932-B-09	FRONT CTRL 54" TO 59 1/2" RETURN PANEL TO 42"	22 1/2" TO 28"	\$1,144	\$1,357	\$1,448	\$1,738	\$2,884
932-B-10	FRONT CTRL 60" TO 65 1/2" RETURN PANEL TO 30"	25 1/2" TO 31"	\$1,131	\$1,332	\$1,417	\$1,689	\$2,768
932-B-11	FRONT CTRL 60" TO 65 1/2" RETURN PANEL TO 36"	25 1/2" TO 31"	\$1,142	\$1,356	\$1,446	\$1,736	\$2,882
932-B-12	FRONT CTRL 60" TO 65 1/2" RETURN PANEL TO 42"	25 1/2" TO 31"	\$1,187	\$1,413	\$1,509	\$1,816	\$3,029
932-B-13	FRONT CTRL 66" TO 71 1/2" RETURN PANEL TO 30"	28 1/2" TO 34"	\$1,185	\$1,398	\$1,488	\$1,778	\$2,924
932-B-14	FRONT CTRL 66" TO 71 1/2" RETURN PANEL TO 36"	28 1/2" TO 34"	\$1,186	\$1,411	\$1,507	\$1,814	\$3,027
932-B-15	FRONT CTRL 66" TO 71 1/2" RETURN PANEL TO 42"	28 1/2" TO 34"	\$1,231	\$1,469	\$1,570	\$1,894	\$3,175

NOTE: WHEN ORDERING, PLEASE PROVIDE CENTERLINE MEASUREMENTS OF TUB, BUTTRESS, LOCATION OF BUTTRESS LEFT OR RIGHT, AND HEIGHT OF BUTTRESS FROM TOP OF TUB TO TOP OF BUTTRESS. (TOP OF BUTTRESS MUST BE A MINIMUM OF 2 1/4" WIDE TO ACCEPT CORNER POST).

CUSTOM HEIGHT: SEE MODEL 982-B

CUTTING LESS THEN STANDARD HEIGHT: ADD 70% TO UNIT LIST PRICE. ADD -CH TO MODEL NO.

BRUSHED SATIN NICKEL FINISH: ADD TO LIST \$ 150.

GOLD ANODIZED FINISH: ADD TO LIST \$ 90.

POWDER COATED FINISH: ALMOND, BISCUIT, BLACK, BONE, CAMEO CREAM, OIL RUBBED BRONZE OR WHITE: ADD TO LIST \$ 450.

CUSTOM COLORS: CONSULT FACTORY.

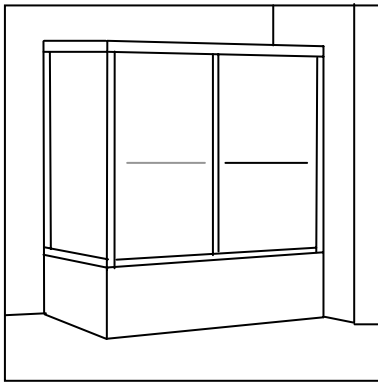

**PRINCESS® FRAMELESS TUB ENCLOSURE
WITH 90° RETURN PANEL
1/4" DIAMOND POLISHED BEVEL GLASS
STANDARD HEIGHT 58 1/2"**

TWO ROLLING PANELS WITH ADJUSTABLE BALL BEARING OVERHEAD SUSPENSION. CLEAN-RITE® OPEN BOTTOM TRACK. HEADER BAR IS REVERSIBLE FOR A ROUND OR A SEMI-FLAT APPEARANCE. HIGH QUALITY THRU THE GLASS TUBULAR BRASS OR 300 SERIES STAINLESS STEEL TOWEL BARS AND KNOBS ON BOTH ROLLING PANELS, CHROME PLATED, 24K GOLD PLATED OR POWDER COATED TO MATCH THE ENCLOSURES FINISH.

MODEL NUMBER	OPENING WIDTH	PASS THRU OPENING	CLEAR	BRONZE OR GRAY	PEBBLE	3/16" RAIN	FLUTED
932-01	FRONT CTRL 42 1/2" TO 47 1/2" RETURN PANEL TO 30"	17" TO 22"	\$968	\$1,131	\$1,200	\$1,422	\$2,298
932-02	FRONT CTRL 42 1/2" TO 47 1/2" RETURN PANEL TO 36"	17" TO 22"	\$1,013	\$1,189	\$1,263	\$1,502	\$2,445
932-03	FRONT CTRL 42 1/2" TO 47 1/2" RETURN PANEL TO 42"	17" TO 22"	\$1,058	\$1,246	\$1,326	\$1,581	\$2,593
932-04	FRONT CTRL 48" TO 53 1/2" RETURN PANEL TO 30"	19 1/2" TO 25"	\$1,021	\$1,197	\$1,271	\$1,510	\$2,454
932-05	FRONT CTRL 48" TO 53 1/2" RETURN PANEL TO 36"	19 1/2" TO 25"	\$1,056	\$1,244	\$1,324	\$1,580	\$2,591
932-06	FRONT CTRL 48" TO 53 1/2" RETURN PANEL TO 42"	19 1/2" TO 25"	\$1,101	\$1,302	\$1,387	\$1,659	\$2,738
932-07	FRONT CTRL 54" TO 59 1/2" RETURN PANEL TO 30"	22 1/2" TO 28"	\$1,077	\$1,265	\$1,344	\$1,600	\$2,611
932-08	FRONT CTRL 54" TO 59 1/2" RETURN PANEL TO 36"	22 1/2" TO 28"	\$1,099	\$1,300	\$1,385	\$1,658	\$2,736
932-09	FRONT CTRL 54" TO 59 1/2" RETURN PANEL TO 42"	22 1/2" TO 28"	\$1,144	\$1,357	\$1,448	\$1,738	\$2,884
932-10	FRONT CTRL 60" TO 65 1/2" RETURN PANEL TO 30"	25 1/2" TO 31"	\$1,131	\$1,332	\$1,417	\$1,689	\$2,768
932-11	FRONT CTRL 60" TO 65 1/2" RETURN PANEL TO 36"	25 1/2" TO 31"	\$1,142	\$1,356	\$1,446	\$1,736	\$2,882
932-12	FRONT CTRL 60" TO 65 1/2" RETURN PANEL TO 42"	25 1/2" TO 31"	\$1,187	\$1,413	\$1,509	\$1,816	\$3,029
932-13	FRONT CTRL 66" TO 71 1/2" RETURN PANEL TO 30"	28 1/2" TO 34"	\$1,185	\$1,398	\$1,488	\$1,778	\$2,924
932-14	FRONT CTRL 66" TO 71 1/2" RETURN PANEL TO 36"	28 1/2" TO 34"	\$1,186	\$1,411	\$1,507	\$1,814	\$3,027
932-15	FRONT CTRL 66" TO 71 1/2" RETURN PANEL TO 42"	28 1/2" TO 34"	\$1,231	\$1,469	\$1,570	\$1,894	\$3,175

NOTE: WHEN ORDERING, PLEASE PROVIDE CENTERLINE MEASUREMENTS AND LOCATION OF RETURN PANEL LEFT OR RIGHT.

CUSTOM HEIGHT: SEE MODEL NO. 982.

CUTTING LESS THEN STANDARD HEIGHT: ADD 70% TO UNIT LIST PRICE. ADD -CH TO MODEL NO.

BRUSHED SATIN NICKEL FINISH: ADD TO LIST \$ 150.

GOLD ANODIZED FINISH: ADD TO LIST \$ 90.

POWDER COATED FINISH: ALMOND, BISCUIT, BLACK, BONE, CAMEO CREAM, OIL RUBBED BRONZE OR WHITE: ADD TO LIST \$ 450.

CUSTOM COLORS: CONSULT FACTORY.

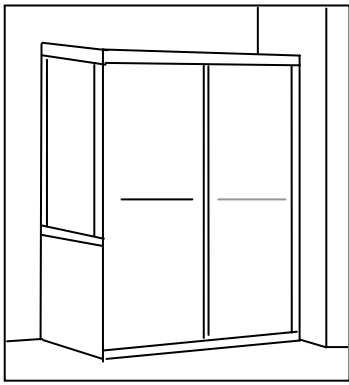

**PRINCESS® FRAMELESS SHOWER ENCLOSURE
WITH 90° BUTTRESS RETURN PANEL
1/4" DIAMOND POLISHED BEVEL GLASS
STANDARD HEIGHT 71 1/2"**

TWO ROLLING PANELS WITH ADJUSTABLE BALL BEARING OVERHEAD SUSPENSION. CLEAN-RITE® OPEN BOTTOM TRACK. HEADER BAR IS REVERSIBLE FOR A ROUND OR A SEMI-FLAT APPEARANCE. HIGH QUALITY THRU THE GLASS TUBULAR BRASS OR 300 SERIES STAINLESS STEEL TOWEL BARS AND KNOBS ON BOTH ROLLING PANELS, CHROME PLATED, 24K GOLD PLATED OR POWDER COATED TO MATCH THE ENCLOSURES FINISH.

MODEL NUMBER	OPENING WIDTH	PASS THRU OPENING	CLEAR	BRONZE OR GRAY	PEBBLE	3/16" RAIN	FLUTED
982-B-01	FRONT CTRL 42 1/2" TO 47 1/2" RETURN PANEL TO 30"	17" TO 22"	\$1,094	\$1,292	\$1,376	\$1,645	\$2,709
982-B-02	FRONT CTRL 42 1/2" TO 47 1/2" RETURN PANEL TO 36"	17" TO 22"	\$1,146	\$1,359	\$1,449	\$1,739	\$2,885
982-B-03	FRONT CTRL 42 1/2" TO 47 1/2" RETURN PANEL TO 42"	17" TO 22"	\$1,197	\$1,426	\$1,522	\$1,833	\$3,061
982-B-04	FRONT CTRL 48" TO 53 1/2" RETURN PANEL TO 30"	19 1/2" TO 25"	\$1,154	\$1,367	\$1,457	\$1,747	\$2,893
982-B-05	FRONT CTRL 48" TO 53 1/2" RETURN PANEL TO 36"	19 1/2" TO 25"	\$1,195	\$1,424	\$1,520	\$1,831	\$3,059
982-B-06	FRONT CTRL 48" TO 53 1/2" RETURN PANEL TO 42"	19 1/2" TO 25"	\$1,247	\$1,491	\$1,594	\$1,925	\$3,235
982-B-07	FRONT CTRL 54" TO 59 1/2" RETURN PANEL TO 30"	22 1/2" TO 28"	\$1,216	\$1,444	\$1,541	\$1,851	\$3,080
982-B-08	FRONT CTRL 54" TO 59 1/2" RETURN PANEL TO 36"	22 1/2" TO 28"	\$1,245	\$1,489	\$1,592	\$1,923	\$3,233
982-B-09	FRONT CTRL 54" TO 59 1/2" RETURN PANEL TO 42"	22 1/2" TO 28"	\$1,297	\$1,556	\$1,665	\$2,017	\$3,409
982-B-10	FRONT CTRL 60" TO 65 1/2" RETURN PANEL TO 30"	25 1/2" TO 31"	\$1,277	\$1,521	\$1,624	\$1,955	\$3,265
982-B-11	FRONT CTRL 60" TO 65 1/2" RETURN PANEL TO 36"	25 1/2" TO 31"	\$1,295	\$1,554	\$1,663	\$2,015	\$3,407
982-B-12	FRONT CTRL 60" TO 65 1/2" RETURN PANEL TO 42"	25 1/2" TO 31"	\$1,347	\$1,621	\$1,737	\$2,109	\$3,583
982-B-13	FRONT CTRL 66" TO 71 1/2" RETURN PANEL TO 30"	28 1/2" TO 34"	\$1,337	\$1,596	\$1,706	\$2,058	\$3,449
982-B-14	FRONT CTRL 66" TO 71 1/2" RETURN PANEL TO 36"	28 1/2" TO 34"	\$1,345	\$1,619	\$1,735	\$2,107	\$3,581
982-B-15	FRONT CTRL 66" TO 71 1/2" RETURN PANEL TO 42"	28 1/2" TO 34"	\$1,396	\$1,686	\$1,808	\$2,201	\$3,757

NOTE: WHEN ORDERING, PLEASE PROVIDE CENTERLINE MEASUREMENTS AND LOCATION OF RETURN PANEL LEFT OR RIGHT.

CUTTING LESS THEN STANDARD HEIGHT: ADD 70% TO UNIT LIST PRICE. ADD -CH TO MODEL NO.

BRUSHED SATIN NICKEL FINISH: ADD TO LIST \$ 150.

GOLD ANODIZED FINISH: ADD TO LIST \$ 90.

POWDER COATED FINISH: ALMOND, BISCUIT, BLACK, BONE, CAMEO CREAM, OIL RUBBED BRONZE OR WHITE: ADD TO LIST \$ 450.

CUSTOM COLORS: CONSULT FACTORY.

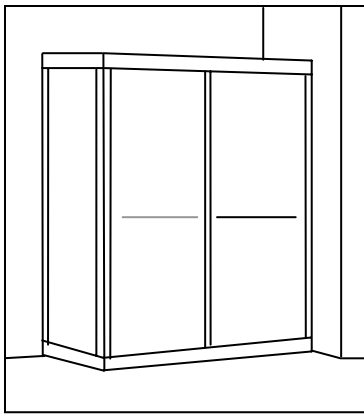

**PRINCESS® FRAMELESS SHOWER ENCLOSURE
WITH 90° RETURN PANEL
1/4" DIAMOND POLISHED BEVEL GLASS
STANDARD HEIGHT 71 1/2"**

TWO ROLLING PANELS WITH ADJUSTABLE BALL BEARING OVERHEAD SUSPENSION. CLEAN-RITE® OPEN BOTTOM TRACK. HEADER BAR IS REVERSIBLE FOR A ROUND OR A SEMI-FLAT APPEARANCE. HIGH QUALITY THRU THE GLASS TUBULAR BRASS OR 300 SERIES STAINLESS STEEL TOWEL BARS AND KNOBS ON BOTH ROLLING PANELS, CHROME PLATED, 24K GOLD PLATED OR POWDER COATED TO MATCH THE ENCLOSURES FINISH.

MODEL NUMBER	OPENING WIDTH	PASS THRU OPENING	CLEAR	BRONZE OR GRAY	PEBBLE	3/16" RAIN	FLUTED
982-01	FRONT CTRL 42 1/2" TO 47 1/2" RETURN PANEL TO 30"	17" TO 22"	\$1,094	\$1,292	\$1,541	\$1,479	\$2,709
982-02	FRONT CTRL 42 1/2" TO 47 1/2" RETURN PANEL TO 36"	17" TO 22"	\$1,146	\$1,359	\$1,615	\$1,573	\$2,885
982-03	FRONT CTRL 42 1/2" TO 47 1/2" RETURN PANEL TO 42"	17" TO 22"	\$1,197	\$1,426	\$1,688	\$1,667	\$3,061
982-04	FRONT CTRL 48" TO 53 1/2" RETURN PANEL TO 30"	19 1/2" TO 25"	\$1,154	\$1,367	\$1,644	\$1,561	\$2,893
982-05	FRONT CTRL 48" TO 53 1/2" RETURN PANEL TO 36"	19 1/2" TO 25"	\$1,195	\$1,424	\$1,707	\$1,645	\$3,059
982-06	FRONT CTRL 48" TO 53 1/2" RETURN PANEL TO 42"	19 1/2" TO 25"	\$1,247	\$1,491	\$1,780	\$1,739	\$3,235
982-07	FRONT CTRL 54" TO 59 1/2" RETURN PANEL TO 30"	22 1/2" TO 28"	\$1,216	\$1,444	\$1,748	\$1,644	\$3,080
982-08	FRONT CTRL 54" TO 59 1/2" RETURN PANEL TO 36"	22 1/2" TO 28"	\$1,245	\$1,489	\$1,799	\$1,716	\$3,233
982-09	FRONT CTRL 54" TO 59 1/2" RETURN PANEL TO 42"	22 1/2" TO 28"	\$1,297	\$1,556	\$1,872	\$1,810	\$3,409
982-10	FRONT CTRL 60" TO 65 1/2" RETURN PANEL TO 30"	25 1/2" TO 31"	\$1,277	\$1,521	\$1,852	\$1,727	\$3,265
982-11	FRONT CTRL 60" TO 65 1/2" RETURN PANEL TO 36"	25 1/2" TO 31"	\$1,295	\$1,554	\$1,891	\$1,788	\$3,407
982-12	FRONT CTRL 60" TO 65 1/2" RETURN PANEL TO 42"	25 1/2" TO 31"	\$1,347	\$1,621	\$1,964	\$1,882	\$3,583
982-13	FRONT CTRL 66" TO 71 1/2" RETURN PANEL TO 30"	28 1/2" TO 34"	\$1,337	\$1,596	\$1,954	\$1,809	\$3,449
982-14	FRONT CTRL 66" TO 71 1/2" RETURN PANEL TO 36"	28 1/2" TO 34"	\$1,345	\$1,619	\$1,983	\$1,859	\$3,581
982-15	FRONT CTRL 66" TO 71 1/2" RETURN PANEL TO 42"	28 1/2" TO 34"	\$1,396	\$1,686	\$2,057	\$1,953	\$3,757

NOTE: WHEN ORDERING, PLEASE PROVIDE CENTERLINE MEASUREMENTS AND LOCATION OF RETURN PANEL LEFT OF RIGHT.

CUTTING LESS THEN STANDARD HEIGHT: ADD 70% TO UNIT LIST PRICE. ADD -CH TO MODEL NO.

BRUSHED SATIN NICKEL FINISH: ADD TO LIST \$ 150.

GOLD ANODIZED FINISH: ADD TO LIST \$ 90.

POWDER COATED FINISH: ALMOND, BISCUIT, BLACK, BONE, CAMEO CREAM, OIL RUBBED BRONZE OR WHITE: ADD TO LIST \$ 450.

CUSTOM COLORS: CONSULT FACTORY.

Victoria® Series Price List NO. 3

February 2009

3/8" DIAMOND POLISHED BEVEL TEMPERED GLASS

We request that all orders for the **Victoria Series** enclosures be placed in writing. All orders must be placed via fax or by mail. Orders will not be placed until the appropriate Style-rite measuring form is received with all of the appropriate dimensions.

Style-rite is not responsible for any inaccuracy in the measurements supplied to us.

Style-rite is not responsible for any personal injury or property damage that may occur when the unit is measured or installed at the customer location.

Orders built to customer specifications will require a 50% production deposit. The remaining balance is per our standard terms.

Orders cancelled during the production period will be pro-rated to the amount of work that has been done on the enclosure including material, labor and custom ordered glass charges.

Style-rite extends to the original consumer purchaser a 3 year limited warranty from the date of purchase on all Style-rite fabricated tub and shower enclosures against defects in material and workmanship. Any enclosure, which proves to be defective under normal use during the warranty period, will be at Style-rite's option to repair or replace with a new or improved part. Style-rite is not responsible for labor, installation costs or shipping charges for the repair or replacement of the defective merchandise. This warranty does not cover defects caused by: improper installation, alteration, misuse or misapplication, maintenance, careless handling, use of harsh chemicals, abrasives, discoloration or stains due to improper water chemistry. Brass finishes including but not limited to towel bars and pulls are not warranted against discoloration or tarnishing due to the inherent characteristics of brass. A coating of Emron or lacquer is applied to brass hardware that helps to protect against discoloration or tarnishing. Except as provided herein, Style-rite makes no warranties either expressed or implied, as to any matter whatsoever including the condition of the merchandise or fitness for a particular purpose. Any warranty implied by law and not effectively excluded by this warranty, is limited to the duration and remedies of this warranty. In no event shall Style-rite be liable for consequential or incidental damages. Glass is not warranted against breakage.

Style-Rite of America®, founded in 1953, is a premier manufacturer of framed and frameless tub and shower enclosures. Style-rite utilizes the finest materials and hand craftsmanship in the industry, giving the customer a superior product. The **Victoria Series** of sliding tub and shower enclosures incorporate the new SR Building Block system™ and guidance system. The SR Building Block System™ consists of interlocking extrusions, which allow flexibility and design options.

VICTORIA® SLIDING TUB AND SHOWER ENCLOSURES

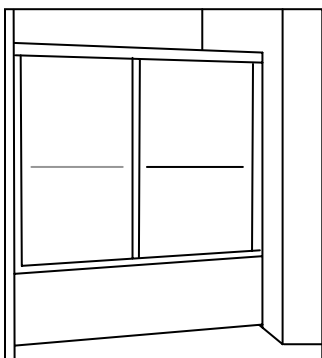

100-L, 100
Pages 15,16

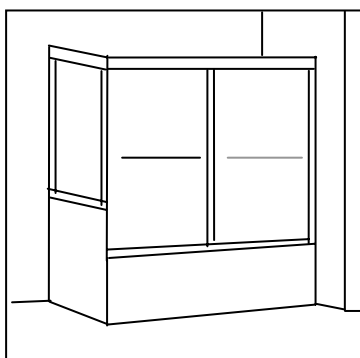

132-B
Page 21

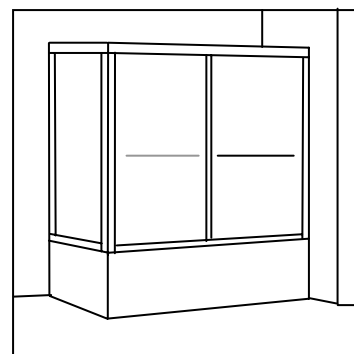

132
Page 22

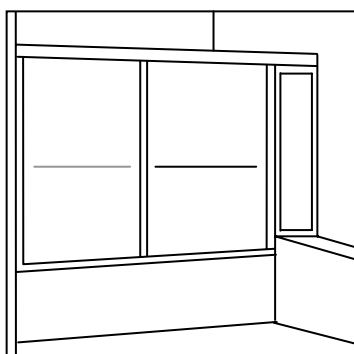

144
Page 19

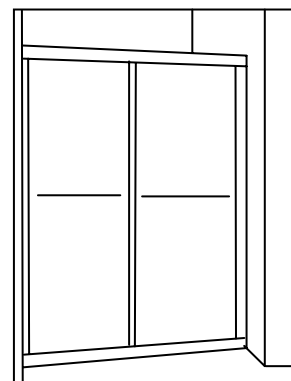

181, 181-H
Pages 17,18

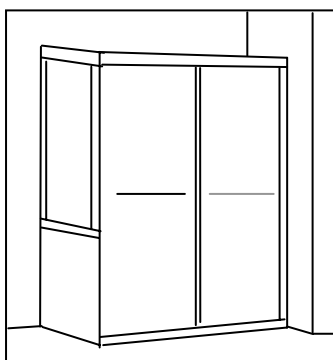

182-B
Page 23

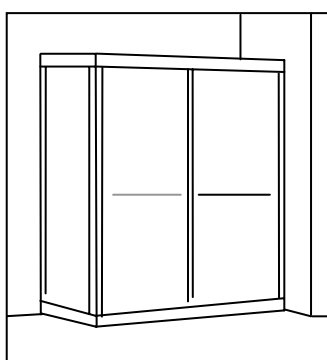

182
Page 24

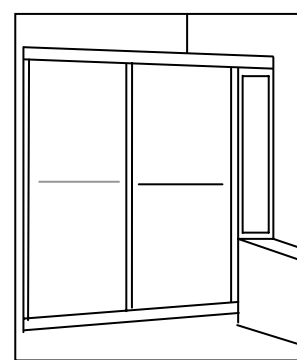

144-H
Page 20

ALUMINUM FINISHES	PAGE 25
GLASS CHARACTERISTICS	25
OPTIONS	25
POLICIES	26
SPECIFICATIONS	BACK PAGE

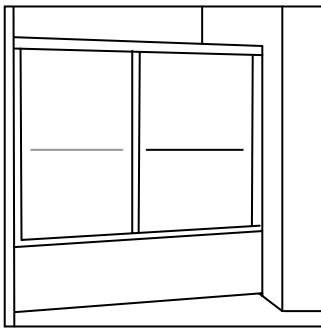

VICTORIA® FRAMELESS TUB ENCLOSURE
3/8" DIAMOND POLISHED BEVEL GLASS
STANDARD HEIGHT 56"

TWO ROLLING PANELS WITH ADJUSTABLE BALL BEARING OVERHEAD SUSPENSION. CLEAN-RITE® OPEN BOTTOM TRACK. HEADER BAR IS REVERSIBLE FOR A ROUND OR A SEMI-FLAT APPEARANCE. HIGH QUALITY THRU THE GLASS TUBULAR BRASS OR 300 SERIES STAINLESS STEEL TOWEL BARS AND KNOBS, CHROME PLATED, 24K GOLD PLATED OR POWDER COATED TO MATCH THE ENCLOSURES FINISH.

MODEL NUMBER	TO FIT OPENING MIN. TO MAX.	PASS THRU OPENING	CLEAR	RAIN	BRONZE, GRAY, PEBBLE	GLUE CHIP
PLEASE ORDER BY MODEL NO. 100-L465	42 1/2"	17"	\$1,071	\$1,403	\$1,509	\$1,928
	43 1/2"	18"	↓	↓	↓	↓
	44 1/2"	19"	↓	↓	↓	↓
	45 1/2"	20"	↓	↓	↓	↓
	46 1/2"	21"	↓	↓	↓	↓
	47 1/2"	22"	↓	↓	↓	↓
100-L525	48"	19 1/2"	\$1,158	\$1,533	\$1,651	\$2,123
	48 1/2"	20"	↓	↓	↓	↓
	49 1/2"	21"	↓	↓	↓	↓
	50 1/2"	22"	↓	↓	↓	↓
	51 1/2"	23"	↓	↓	↓	↓
	52 1/2"	24"	↓	↓	↓	↓
100-L565	53 1/2"	25"	↓	↓	↓	↓
	54"	22 1/2"	\$1,248	\$1,664	\$1,796	\$2,321
	54 1/2"	23"	↓	↓	↓	↓
	55 1/2"	24"	↓	↓	↓	↓
	56 1/2"	25"	↓	↓	↓	↓
	57 1/2"	26"	↓	↓	↓	↓
100-L645	58 1/2"	27"	↓	↓	↓	↓
	59 1/2"	28"	↓	↓	↓	↓
	60"	25 1/2"	\$1,338	\$1,795	\$1,940	\$2,517
	60 1/2"	26"	↓	↓	↓	↓
	61 1/2"	27"	↓	↓	↓	↓
	62 1/2"	28"	↓	↓	↓	↓
100-L705	63 1/2"	29"	↓	↓	↓	↓
	64 1/2"	30"	↓	↓	↓	↓
	65 1/2"	31"	↓	↓	↓	↓
	66"	28 1/2"	\$1,426	\$1,925	\$2,083	\$2,712
	66 1/2"	29"	↓	↓	↓	↓
	67 1/2"	30"	↓	↓	↓	↓
100-L705	68 1/2"	31"	↓	↓	↓	↓
	69 1/2"	32"	↓	↓	↓	↓
	70 1/2"	33"	↓	↓	↓	↓
	71 1/2"	34"	↓	↓	↓	↓

CUSTOM HEIGHT: SEE MODEL NO. 181-H.
 CUTTING LESS THEN STANDARD HEIGHT: ADD 70% TO UNIT LIST PRICE. ADD -CH TO MODEL NO.
 BRUSHED SATIN NICKEL FINISH: ADD TO LIST \$ 100.
 GOLD ANODIZED FINISH: ADD TO LIST \$ 60.
 POWDER COATED FINISH: ALMOND, BISCUIT, BLACK, BONE, CAMEO CREAM, OIL RUBBED BRONZE OR WHITE:
 ADD TO LIST \$ 300.
 CUSTOM COLORS CONSULT FACTORY.

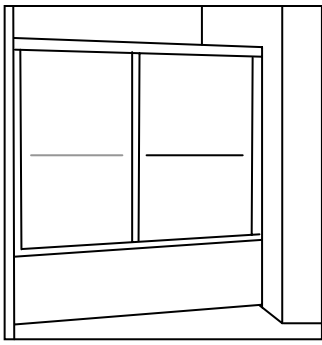

VICTORIA® FRAMELESS TUB ENCLOSURE
3/8" DIAMOND POLISHED BEVEL GLASS
STANDARD HEIGHT 58"

TWO ROLLING PANELS WITH ADJUSTABLE BALL BEARING OVERHEAD SUSPENSION. CLEAN-RITE® OPEN BOTTOM TRACK. HEADER BAR IS REVERSIBLE FOR A ROUND OR A SEMI-FLAT APPEARANCE. HIGH QUALITY THRU THE GLASS TUBULAR BRASS OR 300 SERIES STAINLESS STEEL TOWEL BARS AND KNOBS, CHROME PLATED, 24K GOLD PLATED OR POWDER COATED TO MATCH THE ENCLOSURES FINISH.

MODEL NUMBER	TO FIT OPENING MIN. TO MAX.	PASS THRU OPENING	CLEAR	RAIN	BRONZE, GRAY, PEBBLE	GLUE CHIP
PLEASE ORDER BY MODEL NO. 100-465	42 1/2"	17"	\$1,094	\$1,439	\$1,548	\$1,984
	43 1/2"	18"	↓	↓	↓	↓
	44 1/2"	19"				
	45 1/2"	20"				
	46 1/2"	21"				
	47 1/2"	22"				
100-525	48"	19 1/2"	\$1,184	\$1,572	\$1,695	\$2,185
	48 1/2"	20"	↓	↓	↓	↓
	49 1/2"	21"				
	50 1/2"	22"				
	51 1/2"	23"				
	52 1/2"	24"				
100-585	53 1/2"	25"				
	54"	22 1/2"	\$863	\$1,708	\$1,844	\$2,388
	54 1/2"	23"	↓	↓	↓	↓
	55 1/2"	24"				
	56 1/2"	25"				
	57 1/2"	26"				
100-645	58 1/2"	27"				
	59 1/2"	28"				
	60"	25 1/2"	\$1,368	\$1,842	\$1,992	\$2,591
	60 1/2"	26"	↓	↓	↓	↓
	61 1/2"	27"				
	62 1/2"	28"				
100-705	63 1/2"	29"				
	64 1/2"	30"				
	65 1/2"	31"				
	66"	28 1/2"	\$1,459	\$1,976	\$2,140	\$2,793
	66 1/2"	29"	↓	↓	↓	↓
	67 1/2"	30"				
	68 1/2"	31"				
	69 1/2"	32"				
	70 1/2"	33"				
	71 1/2"	34"				

CUSTOM HEIGHT: SEE MODEL NO. 181-H.

CUTTING LESS THEN STANDARD HEIGHT: ADD 70% TO UNIT LIST PRICE. ADD -CH TO MODEL NO.

BRUSHED SATIN NICKEL FINISH: ADD TO LIST \$ 100.

GOLD ANODIZED FINISH: ADD TO LIST \$ 60.

POWDER COATED FINISH: ALMOND, BISCUIT, BLACK, BONE, CAMEO CREAM, OIL RUBBED BRONZE OR WHITE: ADD TO LIST \$ 300. CUSTOM COLORS CONSULT FACTORY.

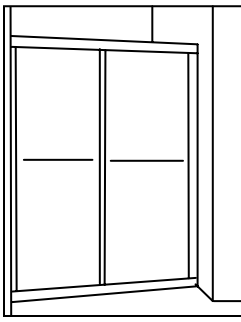

VICTORIA® FRAMELESS SHOWER ENCLOSURE
3/8" DIAMOND POLISHED BEVEL GLASS
STANDARD HEIGHT 66"

TWO ROLLING PANELS WITH ADJUSTABLE BALL BEARING OVERHEAD SUSPENSION. CLEAN-RITE® OPEN BOTTOM TRACK. HEADER BAR IS REVERSIBLE FOR A ROUND OR A SEMI-FLAT APPEARANCE. HIGH QUALITY THRU THE GLASS TUBULAR BRASS OR 300 SERIES STAINLESS STEEL TOWEL BARS AND KNOBS, CHROME PLATED, 24K GOLD PLATED OR POWDER COATED TO MATCH THE ENCLOSURES FINISH.

MODEL NUMBER	TO FIT OPENING MIN. TO MAX.	PASS THRU OPENING	CLEAR	RAIN	BRONZE, GRAY, PEBBLE	GLUE CHIP				
PLEASE ORDER BY MODEL NO. 181-445	40 1/2"	16 1/2"	↓	↓	↓	↓				
	41 1/2"	17 1/2"								
	42 1/2"	18 1/2"								
	43 1/2"	19 1/2"								
	44 1/2"	20 1/2"								
181-465	45 1/2"	20"								
	46 1/2"	21"								
	47 1/2"	22"								
181-525	48"	19 1/2"					\$1,287	\$1,731	\$1,871	\$2,431
	48 1/2"	20"					↓	↓	↓	↓
	49 1/2"	21"								
	50 1/2"	22"								
	51 1/2"	23"								
	52 1/2"	24"								
53 1/2"	25"									
181-585	54"	22 1/2"	\$1,389	\$1,882	\$2,038	\$2,660				
	54 1/2"	23"	↓	↓	↓	↓				
	55 1/2"	24"								
	56 1/2"	25"								
	57 1/2"	26"								
	58 1/2"	27"								
59 1/2"	28"									
181-645	60"	25 1/2"	\$1,489	\$2,032	\$2,203	\$2,887				
	60 1/2"	26"	↓	↓	↓	↓				
	61 1/2"	27"								
	62 1/2"	28"								
	63 1/2"	29"								
	64 1/2"	30"								
65 1/2"	31"									
181-705	66"	28 1/2"	\$1,589	\$2,181	\$2,368	\$3,114				
	66 1/2"	29"	↓	↓	↓	↓				
	67 1/2"	30"								
	68 1/2"	31"								
	69 1/2"	32"								
	70 1/2"	33"								
71 1/2"	34"									

CUSTOM HEIGHT: SEE MODEL NO. 181-H.

CUTTING LESS THEN STANDARD HEIGHT: ADD 70% TO UNIT LIST PRICE. ADD -CH TO MODEL NO.

BRUSHED SATIN NICKEL FINISH: ADD TO LIST \$ 100.

GOLD ANODIZED FINISH: ADD TO LIST \$ 60.

POWDER COATED FINISH: ALMOND, BISCUIT, BLACK, BONE, CAMEO CREAM, OIL RUBBED BRONZE OR WHITE: ADD TO LIST \$ 300. CUSTOM COLORS: CONSULT FACTORY.

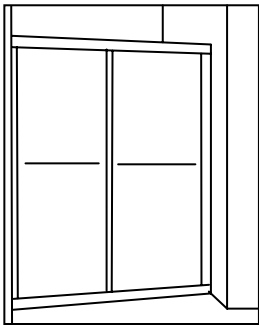

**VICTORIA® FRAMELESS SHOWER ENCLOSURE
3/8" DIAMOND POLISHED BEVEL GLASS
STANDARD HEIGHT 71"**

TWO ROLLING PANELS WITH ADJUSTABLE BALL BEARING OVERHEAD SUSPENSION. CLEAN-RITE® OPEN BOTTOM TRACK. HEADER BAR IS REVERSIBLE FOR A ROUND OR A SEMI-FLAT APPEARANCE. HIGH QUALITY THRU THE GLASS TUBULAR BRASS OR 300 SERIES STAINLESS STEEL TOWEL BARS AND KNOBS, CHROME PLATED, 24K GOLD PLATED OR POWDER COATED TO MATCH THE ENCLOSURES FINISH.

MODEL NUMBER	TO FIT OPENING MIN. TO MAX.	PASS THRU OPENING	CLEAR	RAIN	BRONZE, GRAY, PEBBLE	GLUE CHIP
PLEASE ORDER BY MODEL NO. 181-H465	42 1/2"	17"	\$807	\$1,656	\$1,789	\$2,123
	43 1/2"	18"	↓	↓	↓	↓
	44 1/2"	19"	↓	↓	↓	↓
	45 1/2"	20"	↓	↓	↓	↓
	46 1/2"	21"	↓	↓	↓	↓
	47 1/2"	22"	↓	↓	↓	↓
181-H525	48"	19 1/2"	\$889	\$1,812	\$1,962	\$2,356
	48 1/2"	20"	↓	↓	↓	↓
	49 1/2"	21"	↓	↓	↓	↓
	50 1/2"	22"	↓	↓	↓	↓
	51 1/2"	23"	↓	↓	↓	↓
	52 1/2"	24"	↓	↓	↓	↓
181-H585	53 1/2"	25"	↓	↓	↓	↓
	54"	22 1/2"	\$971	\$1,971	\$2,137	\$2,590
	54 1/2"	23"	↓	↓	↓	↓
	55 1/2"	24"	↓	↓	↓	↓
	56 1/2"	25"	↓	↓	↓	↓
	57 1/2"	26"	↓	↓	↓	↓
181-H645	58 1/2"	27"	↓	↓	↓	↓
	59 1/2"	28"	↓	↓	↓	↓
	60"	25 1/2"	\$1,353	\$2,128	\$2,311	\$2,824
	60 1/2"	26"	↓	↓	↓	↓
	61 1/2"	27"	↓	↓	↓	↓
	62 1/2"	28"	↓	↓	↓	↓
181-H705	63 1/2"	29"	↓	↓	↓	↓
	64 1/2"	30"	↓	↓	↓	↓
	65 1/2"	31"	↓	↓	↓	↓
	66"	28 1/2"	\$1,447	\$2,285	\$2,484	\$3,057
	66 1/2"	29"	↓	↓	↓	↓
	67 1/2"	30"	↓	↓	↓	↓
181-H705	68 1/2"	31"	↓	↓	↓	↓
	69 1/2"	32"	↓	↓	↓	↓
	70 1/2"	33"	↓	↓	↓	↓
	71 1/2"	34"	↓	↓	↓	↓

**CUSTOM HEIGHT UP TO 84": ADD 70% TO UNIT LIST PRICE. ADD -XH TO MODEL NO.
CUTTING LESS THEN STANDARD HEIGHT: ADD 70% TO UNIT LIST PRICE. ADD -CH TO MODEL NO.
BRUSHED SATIN NICKEL FINISH: ADD TO LIST \$ 100.
GOLD ANODIZED FINISH: ADD TO LIST \$ 60.
POWDER COATED FINISH: ALMOND, BISCUIT, BLACK, BONE, CAMEO CREAM, OIL RUBBED BRONZE OR WHITE: ADD TO LIST \$ 300.
CUSTOM COLORS: CONSULT FACTORY.**

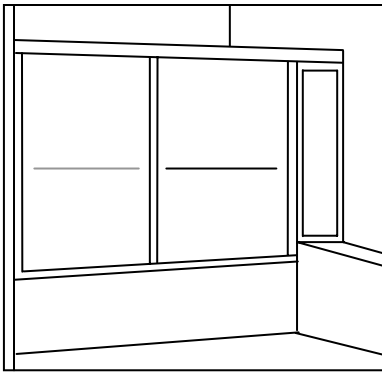

**VICTORIA® FRAMELESS TUB ENCLOSURE
WITH IN-LINE PANEL
3/8" DIAMOND POLISHED BEVEL GLASS
STANDARD HEIGHT 58"**

TWO ROLLING PANELS WITH ADJUSTABLE BALL BEARING OVERHEAD SUSPENSION. CLEAN-RITE® OPEN BOTTOM TRACK. HEADER BAR IS REVERSIBLE FOR A ROUND OR A SEMI-FLAT APPEARANCE. HIGH QUALITY THRU THE GLASS TUBULAR BRASS OR 300 SERIES STAINLESS STEEL TOWEL BARS AND KNOBS ON BOTH ROLLING PANELS, CHROME PLATED, 24K GOLD PLATED OR POWDER COATED TO MATCH THE ENCLOSURES FINISH.

MODEL NUMBER	OPENING WIDTH	PASS THRU OPENING	CLEAR	RAIN	BRONZE, GRAY, PEBBLE	GLUE CHIP
144-01	TUB CTRL 42 1/2" TO 47 1/2" IN-LINE PANEL TO 12"	17" TO 22"	\$1,086	\$1,448	\$1,557	\$2,157
144-02	TUB CTRL 42 1/2" TO 47 1/2" IN-LINE PANEL TO 24"	17" TO 22"	\$1,160	\$1,536	\$1,645	\$2,388
144-03	TUB CTRL 42 1/2" TO 47 1/2" IN-LINE PANEL TO 36"	17" TO 22"	\$1,237	\$1,628	\$1,738	\$2,634
144-04	TUB CTRL 48" TO 53 1/2" IN-LINE PANEL TO 12"	19 1/2" TO 25"	\$1,110	\$1,514	\$1,637	\$2,292
144-05	TUB CTRL 48" TO 53 1/2" IN-LINE PANEL TO 24"	19 1/2" TO 25"	\$1,239	\$1,658	\$1,781	\$2,578
144-06	TUBCTRL 48" TO 53 1/2" IN-LINE PANEL TO 36"	19 1/2" TO 25"	\$1,316	\$1,751	\$1,874	\$2,825
144-07	TUB CTRL 54" TO 59 1/2" IN-LINE PANEL TO 12"	22 1/2" TO 28"	\$1,200	\$1,648	\$1,785	\$2,494
144-08	TUB CTRL 54" TO 59 1/2" IN-LINE PANEL TO 24"	22 1/2" TO 28"	\$1,318	\$1,780	\$1,917	\$2,769
144-09	TUB CTRL 54" TO 59 1/2" IN-LINE PANEL TO 36"	22 1/2" TO 28"	\$1,396	\$1,873	\$2,010	\$3,015
144-10	TUB CTRL 60" TO 65 1/2" IN-LINE PANEL TO 12"	25 1/2" TO 31"	\$1,290	\$1,781	\$1,931	\$2,694
144-11	TUB CTRL 60" TO 65 1/2" IN-LINE PANEL TO 24"	25 1/2" TO 31"	\$1,398	\$1,903	\$2,053	\$2,959
144-12	TUB CTRL 60" TO 65 1/2" IN-LINE PANEL TO 36"	25 1/2" TO 31"	\$1,475	\$1,996	\$2,146	\$3,206
144-13	TUB CTRL 66" TO 71 1/2" IN-LINE PANEL TO 12"	28 1/2" TO 34"	\$1,379	\$1,913	\$2,077	\$2,894
144-14	TUB CTRL 66" TO 71 1/2" IN-LINE PANEL TO 24"	28 1/2" TO 34"	\$1,477	\$2,025	\$2,189	\$3,150
144-15	TUB CTRL 66" TO 71 1/2" IN-LINE PANEL TO 36"	28 1/2" TO 34"	\$1,554	\$2,118	\$2,282	\$3,396

NOTE: WHEN ORDERING, PLEASE PROVIDE CENTERLINE MEASUREMENTS OF BASE, SEAT, LOCATION OF SEAT LEFT OR RIGHT, AND HEIGHT FROM TOP OF BASE TO TOP OF SEAT. CUSTOM HEIGHT UP TO 84": ADD 70% TO UNIT LIST PRICE. ADD -XH TO MEDEL NO. CUTTING LESS THEN STANDARD HEIGHT: ADD 70% TO UNIT LIST PRICE. ADD -CH TO MODEL NO.

BRUSHED SATIN NICKEL FINISH: ADD TO LIST \$ 150.

GOLD ANODIZED FINISH: ADD TO LIST \$ 90.

POWDER COATED FINISH: ALMOND, BISCUIT, BLACK, BONE, CAMEO CREAM, OIL RUBBED BRONZE OR WHITE: ADD TO LIST \$ 450.

CUSTOM COLORS: CONSULT FACTORY.

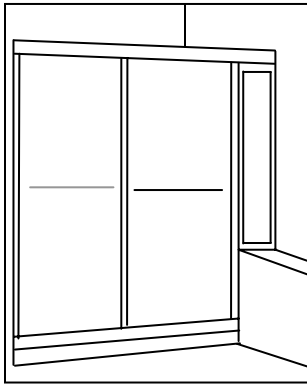

**VICTORIA® FRAMELESS SHOWER ENCLOSURE
WITH IN-LINE PANEL
3/8" DIAMOND POLISHED BEVEL GLASS
STANDARD HEIGHT 71"**

TWO ROLLING PANELS WITH ADJUSTABLE BALL BEARING OVERHEAD SUSPENSION. CLEAN-RITE® OPEN BOTTOM TRACK. HEADER BAR IS REVERSIBLE FOR A ROUND OR A SEMI-FLAT APPEARANCE. HIGH QUALITY THRU THE GLASS TUBULAR BRASS OR 300 SERIES STAINLESS STEEL TOWEL BARS AND KNOBS ON BOTH ROLLING PANELS, CHROME PLATED, 24K GOLD PLATED OR POWDER COATED TO MATCH THE ENCLOSURES FINISH.

MODEL NUMBER	OPENING WIDTH	PASS THRU OPENING	CLEAR	RAIN	BRONZE, GRAY, PEBBLE	GLUE CHIP
144-H-01	BASE CTRL 42 1/2" TO 47 1/2" IN-LINE PANEL TO 12"	17" TO 22"	\$1,236	\$1,673	\$1,806	\$2,521
144-H-02	BASE CTRL 42 1/2" TO 47 1/2" IN-LINE PANEL TO 24"	17" TO 22"	\$1,324	\$1,780	\$1,913	\$2,815
144-H-03	BASE CTRL 42 1/2" TO 47 1/2" IN-LINE PANEL TO 36"	17" TO 22"	\$1,412	\$1,887	\$2,019	\$3,108
144-H-04	BASE CTRL 48" TO 53 1/2" IN-LINE PANEL TO 12"	19 1/2" TO 25"	\$1,260	\$1,750	\$1,899	\$2,681
144-H-05	BASE CTRL 48" TO 53 1/2" IN-LINE PANEL TO 24"	19 1/2" TO 25"	\$1,417	\$1,925	\$2,075	\$3,043
144-H-06	BASE CTRL 48" TO 53 1/2" IN-LINE PANEL TO 36"	19 1/2" TO 25"	\$1,505	\$2,032	\$2,181	\$3,336
144-H-07	BASE CTRL 54" TO 59 1/2" IN-LINE PANEL TO 12"	22 1/2" TO 28"	\$1,364	\$1,907	\$2,073	\$2,920
144-H-08	BASE CTRL 54" TO 59 1/2" IN-LINE PANEL TO 24"	22 1/2" TO 28"	\$1,510	\$2,071	\$2,237	\$3,271
144-H-09	BASE CTRL 54" TO 59 1/2" IN-LINE PANEL TO 36"	22 1/2" TO 28"	\$1,598	\$2,178	\$2,343	\$3,564
144-H-10	BASE CTRL 60" TO 65 1/2" IN-LINE PANEL TO 12"	25 1/2" TO 31"	\$1,468	\$2,063	\$2,245	\$3,158
144-H-11	BASE CTRL 60" TO 65 1/2" IN-LINE PANEL TO 24"	25 1/2" TO 31"	\$1,603	\$2,216	\$2,398	\$3,499
144-H-12	BASE CTRL 60" TO 65 1/2" IN-LINE PANEL TO 36"	25 1/2" TO 31"	\$1,691	\$2,323	\$2,505	\$3,792
144-H-13	BASE CTRL 66" TO 71 1/2" IN-LINE PANEL TO 12"	28 1/2" TO 34"	\$1,570	\$2,217	\$2,416	\$3,396
144-H-14	BASE CTRL 66" TO 71 1/2" IN-LINE PANEL TO 24"	28 1/2" TO 34"	\$1,696	\$2,361	\$2,560	\$3,727
144-H-15	BASE CTRL 66" TO 71 1/2" IN-LINE PANEL TO 36"	28 1/2" TO 34"	\$1,784	\$2,468	\$2,667	\$4,020

NOTE: WHEN ORDERING, PLEASE PROVIDE CENTERLINE MEASUREMENTS OF BASE, SEAT, LOCATION OF SEAT LEFT OR RIGHT, AND HEIGHT FROM TOP OF BASE TO TOP OF SEAT. CUSTOM HEIGHT UP TO 84": ADD 70% TO UNIT LIST PRICE. ADD -XH TO MEDEL NO. CUTTING LESS THEN STANDARD HEIGHT: ADD 70% TO UNIT LIST PRICE. ADD -CH TO MODEL NO.

BRUSHED SATIN NICKEL FINISH: ADD TO LIST \$ 150.

GOLD ANODIZED FINISH: ADD TO LIST \$ 90.

POWDER COATED FINISH: ALMOND, BISCUIT, BLACK, BONE, CAMEO CREAM, OIL RUBBED BRONZE OR WHITE: ADD TO LIST \$ 450.

CUSTOM COLORS: CONSULT FACTORY.

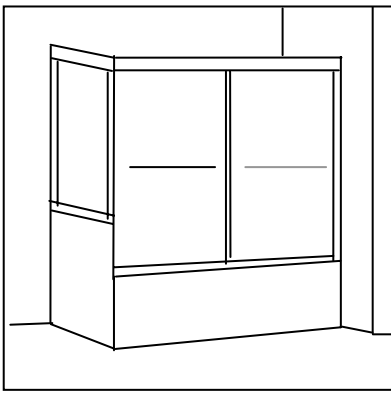

**VICTORIA® FRAMELESS TUB ENCLOSURE
WITH 90° BUTTRESS RETURN PANEL
3/8" DIAMOND POLISHED BEVEL GLASS
STANDARD HEIGHT 58"**

TWO ROLLING PANELS WITH ADJUSTABLE BALL BEARING OVERHEAD SUSPENSION. CLEAN-RITE® OPEN BOTTOM TRACK. HEADER BAR IS REVERSIBLE FOR A ROUND OR A SEMI-FLAT APPEARANCE. HIGH QUALITY THRU THE GLASS TUBULAR BRASS OR 300 SERIES STAINLESS STEEL TOWEL BARS AND KNOBS ON BOTH ROLLING PANELS, CHROME PLATED, 24K GOLD PLATED OR POWDER COATED TO MATCH THE ENCLOSURES FINISH.

MODEL NUMBER	OPENING WIDTH	PASS THRU OPENING	CLEAR	RAIN	BRONZE, GRAY, PEBBLE	GLUE CHIP
132-B-01	FRONT CTRL 42 1/2" TO 47 1/2" RETURN PANEL TO 30"	17" TO 22"	\$1,314	\$1,697	\$1,806	\$2,626
132-B-02	FRONT CTRL 42 1/2" TO 47 1/2" RETURN PANEL TO 36"	17" TO 22"	\$1,355	\$1,747	\$1,856	\$2,752
132-B-03	FRONT CTRL 42 1/2" TO 47 1/2" RETURN PANEL TO 42"	17" TO 22"	\$1,397	\$1,796	\$1,905	\$2,879
132-B-04	FRONT CTRL 48" TO 53 1/2" RETURN PANEL TO 30"	19 1/2" TO 25"	\$1,402	\$1,829	\$1,951	\$2,826
132-B-05	FRONT CTRL 48" TO 53 1/2" RETURN PANEL TO 36"	19 1/2" TO 25"	\$1,435	\$1,869	\$1,992	\$2,943
132-B-06	FRONT CTRL 48" TO 53 1/2" RETURN PANEL TO 42"	19 1/2" TO 25"	\$1,476	\$1,918	\$2,041	\$3,069
132-B-07	FRONT CTRL 54" TO 59 1/2" RETURN PANEL TO 30"	22 1/2" TO 28"	\$1,492	\$1,962	\$2,099	\$3,027
132-B-08	FRONT CTRL 54" TO 59 1/2" RETURN PANEL TO 36"	22 1/2" TO 28"	\$1,514	\$1,991	\$2,128	\$3,133
132-B-09	FRONT CTRL 54" TO 59 1/2" RETURN PANEL TO 42"	22 1/2" TO 28"	\$1,556	\$2,041	\$2,177	\$3,260
132-B-10	FRONT CTRL 60" TO 65 1/2" RETURN PANEL TO 30"	25 1/2" TO 31"	\$1,582	\$2,095	\$2,245	\$3,228
132-B-11	FRONT CTRL 60" TO 65 1/2" RETURN PANEL TO 36"	25 1/2" TO 31"	\$1,593	\$2,114	\$2,264	\$3,324
132-B-12	FRONT CTRL 60" TO 65 1/2" RETURN PANEL TO 42"	25 1/2" TO 31"	\$1,635	\$2,163	\$2,313	\$3,450
132-B-13	FRONT CTRL 66" TO 71 1/2" RETURN PANEL TO 30"	28 1/2" TO 34"	\$1,671	\$2,227	\$2,391	\$3,428
132-B-14	FRONT CTRL 66" TO 71 1/2" RETURN PANEL TO 36"	28 1/2" TO 34"	\$1,672	\$2,236	\$2,400	\$3,514
132-B-15	FRONT CTRL 66" TO 71 1/2" RETURN PANEL TO 42"	28 1/2" TO 34"	\$1,714	\$2,286	\$2,449	\$3,641

NOTE: WHEN ORDERING, PLEASE PROVIDE CENTERLINE MEASUREMENTS OF TUB, BUTTRESS, LOCATION OF BUTTRESS LEFT OR RIGHT, AND HEIGHT OF BUTTRESS FROM TOP OF TUB TO TOP OF BUTTRESS. (TOP OF BUTTRESS MUST BE A MINIMUM OF 2 1/4" WIDE TO ACCEPT CORNER POST).

CUSTOM HEIGHT: SEE MODEL NO. 182-B.

CUTTING LESS THEN STANDARD HEIGHT: ADD 70% TO UNIT LIST PRICE. ADD -CH TO MODEL NO.

BRUSHED SATIN NICKEL FINISH: ADD TO LIST \$ 150.

GOLD ANODIZED FINISH: ADD TO LIST \$ 90.

POWDER COATED FINISH: ALMOND, BISCUIT, BLACK, BONE, CAMEO CREAM, OIL RUBBED BRONZE OR WHITE: ADD TO LIST \$ 450.

CUSTOM COLORS: CONSULT FACTORY.

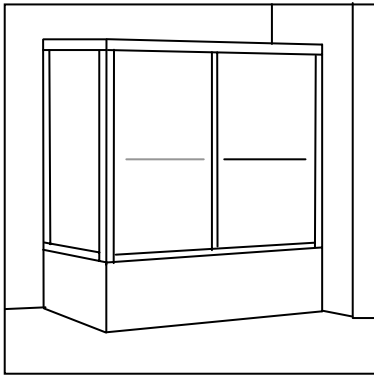

**VICTORIA® FRAMELESS TUB ENCLOSURE
WITH 90° RETURN PANEL.
3/8" DIAMOND POLISHED BEVEL GLASS
STANDARD HEIGHT 58"**

TWO ROLLING PANELS WITH ADJUSTABLE BALL BEARING OVERHEAD SUSPENSION. CLEAN-RITE® OPEN BOTTOM TRACK. HEADER BAR IS REVERSIBLE FOR A ROUND OR A SEMI-FLAT APPEARANCE. HIGH QUALITY THRU THE GLASS TUBULAR BRASS OR 300 SERIES STAINLESS STEEL TOWEL BARS AND KNOBS ON BOTH ROLLING PANELS, CHROME PLATED, 24K GOLD PLATED OR POWDER COATED TO MATCH THE ENCLOSURES FINISH.

MODEL NUMBER	OPENING WIDTH	PASS THRU OPENING	CLEAR	RAIN	BRONZE, GRAY, PEBBLE	GLUE CHIP
132-01	FRONT CTRL 42 1/2" TO 47 1/2" RETURN PANEL TO 30"	17" TO 22"	\$1,314	\$1,697	\$1,806	\$2,626
132-02	FRONT CTRL 42 1/2" TO 47 1/2" RETURN PANEL TO 36"	17" TO 22"	\$1,355	\$1,747	\$1,856	\$2,752
132-03	FRONT CTRL 42 1/2" TO 47 1/2" RETURN PANEL TO 42"	17" TO 22"	\$1,397	\$1,796	\$1,905	\$2,879
132-04	FRONT CTRL 48" TO 53 1/2" RETURN PANEL TO 30"	19 1/2" TO 25"	\$1,402	\$1,829	\$1,951	\$2,826
132-05	FRONT CTRL 48" TO 53 1/2" RETURN PANEL TO 36"	19 1/2" TO 25"	\$1,435	\$1,869	\$1,992	\$2,943
132-06	FRONT CTRL 48" TO 53 1/2" RETURN PANEL TO 42"	19 1/2" TO 25"	\$1,476	\$1,918	\$2,041	\$3,069
132-07	FRONT CTRL 54" TO 59 1/2" RETURN PANEL TO 30"	22 1/2" TO 28"	\$1,492	\$1,962	\$2,099	\$3,027
132-08	FRONT CTRL 54" TO 59 1/2" RETURN PANEL TO 36"	22 1/2" TO 28"	\$1,514	\$1,991	\$2,128	\$3,133
132-09	FRONT CTRL 54" TO 59 1/2" RETURN PANEL TO 42"	22 1/2" TO 28"	\$1,556	\$2,041	\$2,177	\$3,260
132-10	FRONT CTRL 60" TO 65 1/2" RETURN PANEL TO 30"	25 1/2" TO 31"	\$1,582	\$2,095	\$2,245	\$3,228
132-11	FRONT CTRL 60" TO 65 1/2" RETURN PANEL TO 36"	25 1/2" TO 31"	\$1,593	\$2,114	\$2,264	\$3,324
132-12	FRONT CTRL 60" TO 65 1/2" RETURN PANEL TO 42"	25 1/2" TO 31"	\$1,635	\$2,163	\$2,313	\$3,450
132-13	FRONT CTRL 66" TO 71 1/2" RETURN PANEL TO 30"	28 1/2" TO 34"	\$1,671	\$2,227	\$2,391	\$3,428
132-14	FRONT CTRL 66" TO 71 1/2" RETURN PANEL TO 36"	28 1/2" TO 34"	\$1,672	\$2,236	\$2,400	\$3,514
132-15	FRONT CTRL 66" TO 71 1/2" RETURN PANEL TO 42"	28 1/2" TO 34"	\$1,714	\$2,286	\$2,449	\$3,641

NOTE: WHEN ORDERING, PLEASE PROVIDE CENTERLINE MEASUREMENTS AND LOCATION OF RETURN PANEL LEFT OR RIGHT.

CUSTOM HEIGHT: SEE MODEL NO. 182.

CUTTING LESS THEN STANDARD HEIGHT: ADD 70% TO UNIT LIST PRICE. ADD -CH TO MODEL NO.

BRUSHED SATIN NICKEL FINISH: ADD TO LIST \$ 150.

GOLD ANODIZED FINISH: ADD TO LIST \$ 90.

POWDER COATED FINISH: ALMOND, BISCUIT, BLACK, BONE, CAMEO CREAM, OIL RUBBED BRONZE OR WHITE: ADD TO LIST \$ 450.

CUSTOM COLORS: CONSULT FACTORY.

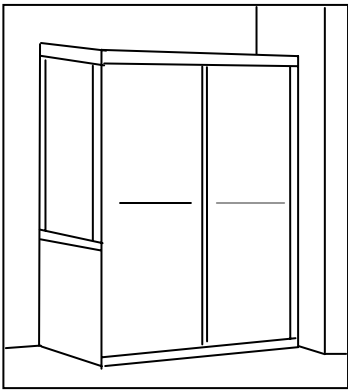

**VICTORIA® FRAMELESS SHOWER ENCLOSURE
WITH 90° BUTTRESS RETURN PANEL
3/8" DIAMOND POLISHED BEVEL GLASS
STANDARD HEIGHT 71"**

TWO ROLLING PANELS WITH ADJUSTABLE BALL BEARING OVERHEAD SUSPENSION. CLEAN-RITE® OPEN BOTTOM TRACK. HEADER BAR IS REVERSIBLE FOR A ROUND OR A SEMI-FLAT APPEARANCE. HIGH QUALITY THRU THE GLASS TUBULAR BRASS OR 300 SERIES STAINLESS STEEL TOWEL BARS AND KNOBS ON BOTH ROLLING PANELS, CHROME PLATED, 24K GOLD PLATED OR POWDER COATED TO MATCH THE ENCLOSURES FINISH.

MODEL NUMBER	OPENING WIDTH	PASS THRU OPENING	CLEAR	RAIN	BRONZE, GRAY, PEBBLE	GLUE CHIP
182-B-01	FRONT CTRL 42 1/2" TO 47 1/2" RETURN PANEL TO 30"	17" TO 22"	\$1,499	\$1,965	\$2,097	\$3,093
182-B-02	FRONT CTRL 42 1/2" TO 47 1/2" RETURN PANEL TO 36"	17" TO 22"	\$1,546	\$2,021	\$2,154	\$3,243
182-B-03	FRONT CTRL 42 1/2" TO 47 1/2" RETURN PANEL TO 42"	17" TO 22"	\$1,593	\$2,078	\$2,210	\$3,392
182-B-04	FRONT CTRL 48" TO 53 1/2" RETURN PANEL TO 30"	19 1/2" TO 25"	\$1,601	\$2,119	\$2,268	\$3,330
182-B-05	FRONT CTRL 48" TO 53 1/2" RETURN PANEL TO 36"	19 1/2" TO 25"	\$1,639	\$2,166	\$2,316	\$3,471
182-B-06	FRONT CTRL 48" TO 53 1/2" RETURN PANEL TO 42"	19 1/2" TO 25"	\$1,686	\$2,223	\$2,372	\$3,620
182-B-07	FRONT CTRL 54" TO 59 1/2" RETURN PANEL TO 30"	22 1/2" TO 28"	\$1,705	\$2,276	\$2,441	\$3,569
182-B-08	FRONT CTRL 54" TO 59 1/2" RETURN PANEL TO 36"	22 1/2" TO 28"	\$1,732	\$2,312	\$2,478	\$3,699
182-B-09	FRONT CTRL 54" TO 59 1/2" RETURN PANEL TO 42"	22 1/2" TO 28"	\$1,779	\$2,368	\$2,534	\$3,848
182-B-10	FRONT CTRL 60" TO 65 1/2" RETURN PANEL TO 30"	25 1/2" TO 31"	\$1,809	\$2,431	\$2,614	\$3,807
182-B-11	FRONT CTRL 60" TO 65 1/2" RETURN PANEL TO 36"	25 1/2" TO 31"	\$1,825	\$2,457	\$2,640	\$3,927
182-B-12	FRONT CTRL 60" TO 65 1/2" RETURN PANEL TO 42"	25 1/2" TO 31"	\$1,872	\$2,514	\$2,696	\$4,077
182-B-13	FRONT CTRL 66" TO 71 1/2" RETURN PANEL TO 30"	28 1/2" TO 34"	\$1,911	\$2,586	\$2,785	\$4,045
182-B-14	FRONT CTRL 66" TO 71 1/2" RETURN PANEL TO 36"	28 1/2" TO 34"	\$1,918	\$2,603	\$2,802	\$4,155
182-B-15	FRONT CTRL 66" TO 71 1/2" RETURN PANEL TO 42"	28 1/2" TO 34"	\$1,965	\$2,659	\$2,858	\$4,305

NOTE: WHEN ORDERING, PLEASE PROVIDE CENTERLINE MEASUREMENTS OF BASE, BUTTRESS, LOCATION OF BUTTRESS LEFT OR RIGHT, AND HEIGHT OF BUTTRESS FROM TOP OF CURB TO TOP OF BUTTRESS. (TOP OF BUTTRESS MUST BE A MINIMUM OF 2 1/4" WIDE TO ACCEPT CORNER POST).

**CUSTOM HEIGHT UP TO 84": ADD 70% TO UNIT LIST PRICE. ADD -XH TO MODEL NO.
CUTTING LESS THEN STANDARD HEIGHT: ADD 70% TO UNIT LIST PRICE. ADD -CH TO MODEL NO.**

BRUSHED SATIN NICKEL FINISH: ADD TO LIST \$ 150.

GOLD ANODIZED FINISH: ADD TO LIST \$ 90.

POWDER COATED FINISH: ALMOND, BISCUIT, BLACK, BONE, CAMEO CREAM, OIL RUBBED BRONZE OR WHITE: ADD TO LIST \$ 450.

CUSTOM COLORS: CONSULT FACTORY.

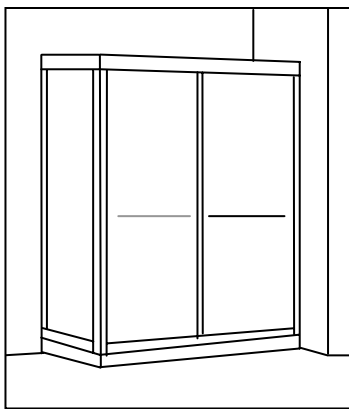

**VICTORIA® FRAMELESS SHOWER ENCLOSURE
WITH 90° RETURN PANEL
3/8" DIAMOND POLISHED BEVEL GLASS
STANDARD HEIGHT 71"**

TWO ROLLING PANELS WITH ADJUSTABLE BALL BEARING OVERHEAD SUSPENSION. CLEAN-RITE® OPEN BOTTOM TRACK. HEADER BAR IS REVERSIBLE FOR A ROUND OR A SEMI-FLAT APPEARANCE. HIGH QUALITY THRU THE GLASS TUBULAR BRASS OR 300 SERIES STAINLESS STEEL TOWEL BARS AND KNOBS ON BOTH ROLLING PANELS, CHROME PLATED, 24K GOLD PLATED OR POWDER COATED TO MATCH THE ENCLOSURES FINISH.

MODEL NUMBER	OPENING WIDTH	PASS THRU OPENING	CLEAR	RAIN	BRONZE, GRAY, PEBBLE	GLUE CHIP
182-01	FRONT CTRL 42 1/2" TO 47 1/2" RETURN PANEL TO 30"	17" TO 22"	\$1,499	\$1,965	\$2,097	\$3,093
182-02	FRONT CTRL 42 1/2" TO 47 1/2" RETURN PANEL TO 36"	17" TO 22"	\$1,546	\$2,021	\$2,154	\$3,243
182-03	FRONT CTRL 42 1/2" TO 47 1/2" RETURN PANEL TO 42"	17" TO 22"	\$1,593	\$2,078	\$2,210	\$3,392
182-04	FRONT CTRL 48" TO 53 1/2" RETURN PANEL TO 30"	19 1/2" TO 25"	\$1,601	\$2,119	\$2,268	\$3,330
182-05	FRONT CTRL 48" TO 53 1/2" RETURN PANEL TO 36"	19 1/2" TO 25"	\$1,639	\$2,166	\$2,316	\$3,471
182-06	FRONT CTRL 48" TO 53 1/2" RETURN PANEL TO 42"	19 1/2" TO 25"	\$1,686	\$2,223	\$2,372	\$3,620
182-07	FRONT CTRL 54" TO 59 1/2" RETURN PANEL TO 30"	22 1/2" TO 28"	\$1,705	\$2,276	\$2,441	\$3,569
182-08	FRONT CTRL 54" TO 59 1/2" RETURN PANEL TO 36"	22 1/2" TO 28"	\$1,732	\$2,312	\$2,478	\$3,699
182-09	FRONT CTRL 54" TO 59 1/2" RETURN PANEL TO 42"	22 1/2" TO 28"	\$1,779	\$2,368	\$2,534	\$3,848
182-10	FRONT CTRL 60" TO 65 1/2" RETURN PANEL TO 30"	25 1/2" TO 31"	\$1,809	\$2,431	\$2,614	\$3,807
182-11	FRONT CTRL 60" TO 65 1/2" RETURN PANEL TO 36"	25 1/2" TO 31"	\$1,825	\$2,457	\$2,640	\$3,927
182-12	FRONT CTRL 60" TO 65 1/2" RETURN PANEL TO 42"	25 1/2" TO 31"	\$1,872	\$2,514	\$2,696	\$4,077
182-13	FRONT CTRL 66" TO 71 1/2" RETURN PANEL TO 30"	28 1/2" TO 34"	\$1,911	\$2,586	\$2,785	\$4,045
182-14	FRONT CTRL 66" TO 71 1/2" RETURN PANEL TO 36"	28 1/2" TO 34"	\$1,918	\$2,603	\$2,802	\$4,155
182-15	FRONT CTRL 66" TO 71 1/2" RETURN PANEL TO 42"	28 1/2" TO 34"	\$1,965	\$2,659	\$2,858	\$4,305

NOTE: WHEN ORDERING, PLEASE PROVIDE CENTERLINE MEASUREMENTS AND LOCATION OF RETURN PANEL LEFT OR RIGHT.

CUSTOM HEIGHT UP TO 84": ADD 70% TO UNIT LIST PRICE. ADD -XH TO MODEL NO.

CUTTING LESS THEN STANDARD HEIGHT: ADD 70% TO UNIT LIST PRICE. ADD -CH TO MODEL NO.

BRUSHED SATIN NICKEL FINISH: ADD TO LIST \$ 150.

GOLD ANODIZED FINISH: ADD TO LIST \$ 90.

POWDER COATED FINISH: ALMOND, BISCUIT, BLACK, BONE, CAMEO CREAM, OIL RUBBED BRONZE OR WHITE: ADD TO LIST \$ 450.

CUSTOM COLORS: CONSULT FACTORY.

ALUMINUM FINISHES AND GLASS CHARACTERISTICS

BRUSHED NICKEL FINISH: SHADE AND COLOR WILL VARY AMONG ADJOINING EXTRUSIONS. THIS SHADE AND COLOR VARIATION IS WITHIN TOLERANCES ESTABLISHED BY THE ANODIZING INDUSTRY AND IS SOLD SUBJECT TO THIS CONDITION.

GOLD ANODIZED FINISH: SHADE AND COLOR WILL VARY AMONG ADJOINING EXTRUSIONS. THIS SHADE AND COLOR VARIATION IS WITHIN TOLERANCES ESTABLISHED BY THE ANODIZING INDUSTRY AND IS SOLD SUBJECT TO THIS CONDITION.

NOTE: TEMPERED GLASS MAY SHATTER WITHOUT ANY APPARENT CAUSE. ALTHOUGH BREAKAGE IS VERY RARE, WE CANNOT BE RESPONSIBLE FOR THIS AS ALL MANUFACTURES OF TEMPERED GLASS DO NOT GUARANTEE AGAINST THIS OCCURRENCE.

TEMPERED GLASS TOLERANCES: STANDARD ALLOWABLE MANUFACTURING TOLERANCES FOR FLATNESS, LOCAL KINK OR WARP IS 1/16" PER LINEAL FOOT.

TEMPERED GLASS: GLASS IS MANUFACTURED BY A ROUGH ROLLED PROCESS. TEAR DROPS, TEAR STREAKS, BUBBLES, BURN MARKS, ETC., ARE PART OF THE CHARACTERISTICS AND NATURE OF THIS TYPE OF GLASS. THIS MATERIAL IS PURCHASED SUBJECT TO THESE CONDITIONS AND IS NOT TO BE CONSIDERED DEFECTIVE.

CUSTOM ORDERED TEMPERED GLASS

NOTE: UNITS ORDERED WITH CUSTOM TEMPERED GLASS CANNOT BE CANCELED. FACTORY ORDER - ALLOW 3 TO 4 WEEKS DELIVERY.

CUSTOM TEMPERED GLASS: ADD TO UNIT PRICE THE FOLLOWING:

1/4" ANTIQUE	\$ 59.00 SQ. FT.	3/8" ANTIQUE	\$ 83.00 SQ. FT.
1/4" BRONZE OR GRAY	\$ 18.00 SQ. FT.	3/8" BRONZE OR GRAY	\$ 22.00 SQ. FT.
1/4" BRONZE OR GRAY SOLARCOOL	\$ 22.00 SQ. FT.	3/8" BUBBLE	\$ 44.00 SQ. FT.
1/4" CLEAR	\$ 15.00 SQ. FT.	3/8" CLEAR	\$ 20.00 SQ. FT.
1/4" CRYSTAL CLEAR	\$ 17.00 SQ. FT.	3/8" CRYSTAL CLEAR	\$ 24.00 SQ. FT.
1/4" SATIN ETCHED	\$ 42.00 SQ. FT.	3/8" FLUTEX	\$ 29.00 SQ. FT.
1/4" FLUTED	\$ 42.00 SQ. FT.	3/8" GLACIER	\$ 29.00 SQ. FT.
1/4" GLUE CHIP	\$ 47.00 SQ. FT.	3/8" GLUE CHIP	\$ 55.00 SQ. FT.
1/4" PEBBLE	\$ 22.00 SQ. FT.	3/8" PEBBLE	\$ 29.00 SQ. FT.
3/16" RAIN	\$ 26.00 SQ. FT.	3/8" RAIN	\$ 29.00 SQ. FT.
		3/8" SATIN ETCHED	\$ 45.00 SQ. FT.

OPTIONS

OVERSIZE WIDTH: ADD TO UNIT LIST PRICE \$ 40. FOR EACH ADDITIONAL 6" OR ANY FRACTION THEREOF OVER STANDARD SIZES SHOWN PLUS PRICE FOR CUSTOM GLASS.

TAPERED FILLERS: CUSTOM MADE TO FIT OUT OF PLUMB WALL CONDITIONS OR OFF LEVEL BASES OR TUBS. ADD TO UNIT LIST PRICE \$ 60. PER FILLER FOR ANY SIZE UP TO 0 - 1". (FOR BOTTOM FILLER PLEASE SPECIFY LEFT TO RIGHT TAPER).

TAPERED BASE WALL FILLERS: USED FOR FIBERGLASS MODULES WITH WALLS THAT TAPER AT BASE. 0 - 1" ADD TO UNIT LIST PRICE \$ 60. PER FILLER

STYLE-RITE® POLICIES

FREIGHT

\$15.00 CHARGE PER DROP OFF. OUTSIDE OUR DELIVERY AREA ALL ORDERS ARE SHIPPED F.O.B. CLIFTON, NJ. FOR DAMAGE ARISING IN TRANSIT, FILE YOUR CLAIM DIRECTLY WITH THE CARRIER.

RETURNED MERCHANDISE

- 1. ALL RETURNS MUST BE FREIGHT PREPAID.**
- 2. MERCHANDISE WILL NOT BE ACCEPTED UNLESS OUR WRITTEN AUTHORIZATION ACCOMPANIES SHIPMENT.**
- 3. ITEMS RETURNED MUST BE PACKED SECURELY IN ORIGINAL PACKAGING. (DO NOT USE TAPE ON MOLDINGS OR GLASS TO SECURE PARTS) WRAP IN PAPER.**
- 4. CREDIT WILL BE ISSUED ONLY UPON INSPECTION OF RETURNED MERCHANDISE SUBJECT TO INSPECTION CHARGES, REPACKAGING CHARGES AND FREIGHT CHARGES IF APPLICABLE.**
- 5. CUSTOM MADE UNITS ARE NOT RETURNABLE.**

RESTOCKING CHARGES

- 1. READY SHIP UNITS CANCELED PRIOR TO SHIPPING WILL NOT INCUR A CANCELLATION CHARGE.**
- 2. READY SHIP UNITS WHICH HAVE BEEN DELIVERED OR SHIPPED ARE SUBJECT TO A \$35.00 RESTOCKING CHARGE.**
- 3. UNITS OTHER THAN READY SHIP ARE SUBJECT TO A \$50.00 RESTOCKING CHARGE.**
- 4. CUSTOM MADE UNITS WHICH INCLUDE CUSTOM WIDTH, HEIGHT, FINISH, GLASS TYPE OR BUTTRESS UNITS, etc. CANNOT BE RETURNED.**

TERMS

1% - 10 NET 30 DAYS

PRICES AND SPECIFICATIONS ARE SUBJECT TO CHANGE WITHOUT NOTICE.

DUKE, DUCHESS, PRINCESS, VICTORIA AND CLEAN-RITE ARE REGISTERED TRADE-MARKS OF STYLE-RITE OF AMERICA®, INC.

“QUALITY IS OUR STYLE” IS A TRADEMARK OF STYLE-RITE OF AMERICA®, INC.

SPECIFICATIONS FOR STYLE-RITE® ENCLOSURES

GENERAL: ALUMINUM SHOWER ENCLOSURES SHALL BE AS MANUFACTURED BY STYLE-RITE of AMERICA®, INC., CLIFTON, NJ.

GLAZING: ALL ENCLOSURES ARE GLAZED WITH SAFETY TEMPERED GLASS CONFORMING TO THE ANSI Z97.1 SPECIFICATIONS.

CONSTRUCTION: ALL ROLLING PANELS TO BE PROVIDED WITH ADJUSTABLE OVERHEAD BALL BEARING SUSPENSION, U-TYPE SIDE JAMBS FOR PRINCESS, E-TYPE SIDE JAMBS FOR VICTORIA, CLEAN-RITE® OPEN BOTTOM TRACK, BOTTOM GUIDES, AND MATCHING TOWEL BARS.

MATERIAL: ALL ALUMINUM SHALL BE EXTRUDED 6063 OR 6463 ALLOY WITH T-5 OR T-6 TEMPER. ALL PANEL FASTENERS SHALL BE 410 HARD STAINLESS STEEL. ROLLERS SHALL BE BALL BEARING WITH NYLON OR POLYMER OUTER RACE.

FINISH: MOLDINGS ARE POLISHED PRIOR TO BEING BRIGHT DIPPED AND ANODIZED UTILIZING ALCOA R-5 PROCESS.

PAINTED FINISHES: SHALL BE OVEN CURED POWDER COATED.

GLASS THICKNESS: 3/16", 1/4", 3/8".

Duke®, Duchess®, Princess®, Victoria® and Clean-Rite® are registered trademarks of Style-Rite of America®, Inc.

Manufacturers of Quality Shower & Tub Enclosures

Style-Rite of America®, Inc.

118 Seger Avenue Clifton, New Jersey 07011

•973-478-1100 • 800-448-3667 • FAX 973-478-7880

DISTRIBUTED BY